

Course: 3D Design
Title: Mesh Modeling – Candle
Dropbox File: Candle.zip
Blender: Version 2.41
Level: Beginning
Author: Neal Hirsig (nhirsig@tufts.edu)

Mesh Modeling – Candle

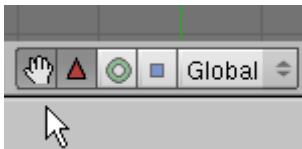

Open a new Blender file. Delete the default cube (if present). Make sure the 3D viewport is in Top View (NUM7). Make sure that the 3D Transform widget is activated.



We will first model a simple candle holder.

Place your 3D cursor in the center of the display. Press Space / Add / Mesh / Circle.

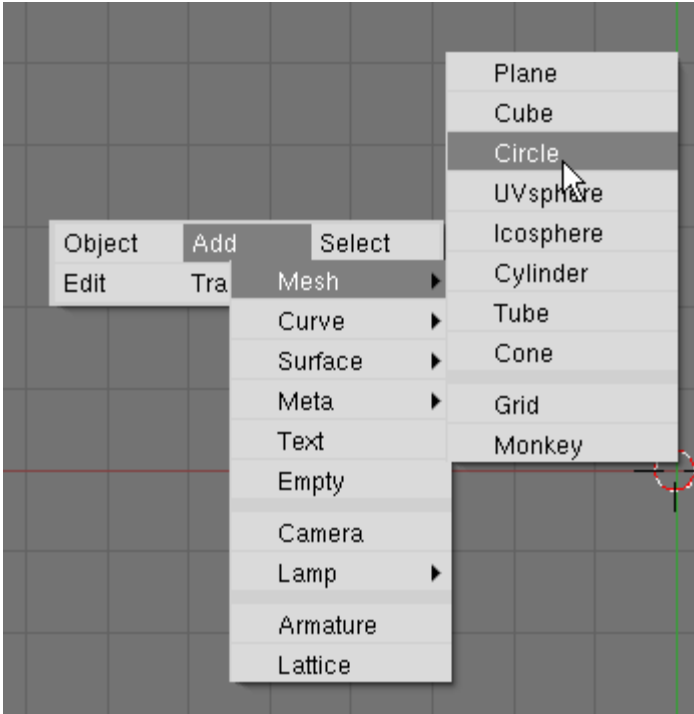

Set the vertices to 16. A circle mesh is placed on the display and is automatically in Edit Mode with all of the vertices selected.

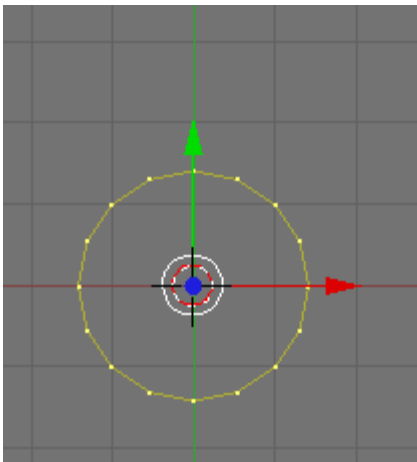

Switch to Side View (NUM3). Press the EKEY (Extrude). Choose Only Edges from the pop-up menu.

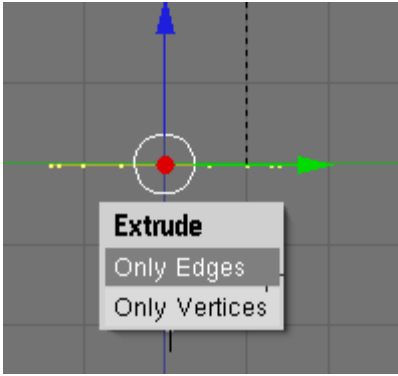

Extrude the edges of the circle up a very short distance as shown below (LMB click to drop in position).

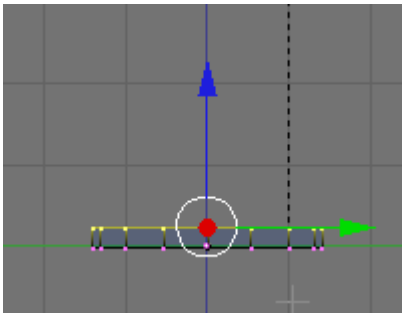

Press the EKEY (Extrude) and extrude the edges up as shown below.

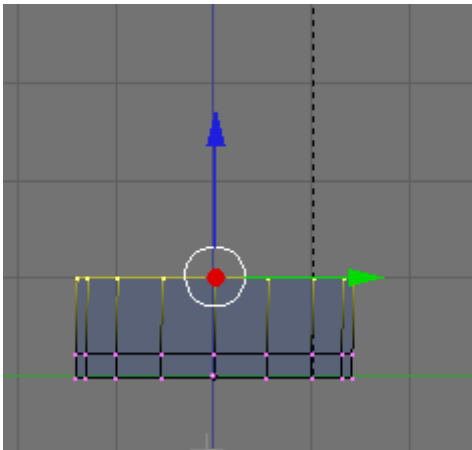

Press the SKEY (Scale) and scale the vertices out as shown below.

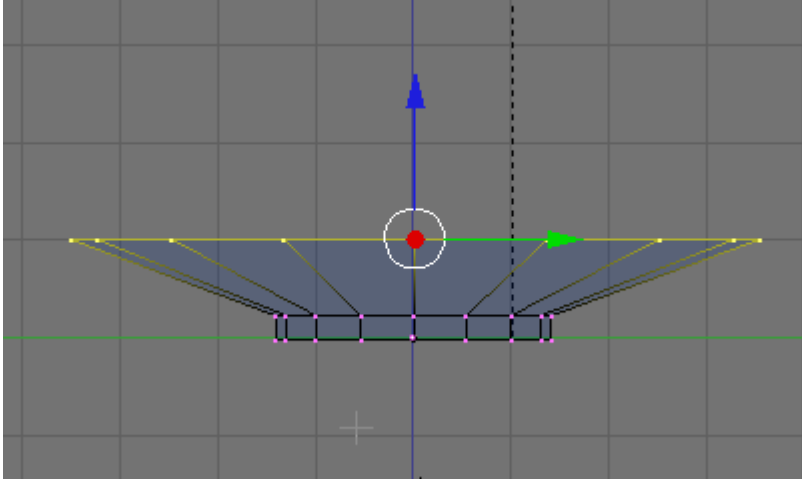

Now that we have a base object we should split our 3D viewport to see the model in perspective. Click in the viewport and then move your cursor to the top of the screen until the cursor becomes a double arrow icon. RMB click and choose Split Area.



A vertical line will appear. Place it in the center of the display.



Click in the right window and change the view to Perspective (NUM5). You should be able to rotate and position the viewport so that you get a nice perspective view. Place the Perspective viewport in Shaded mode (ZKEY).

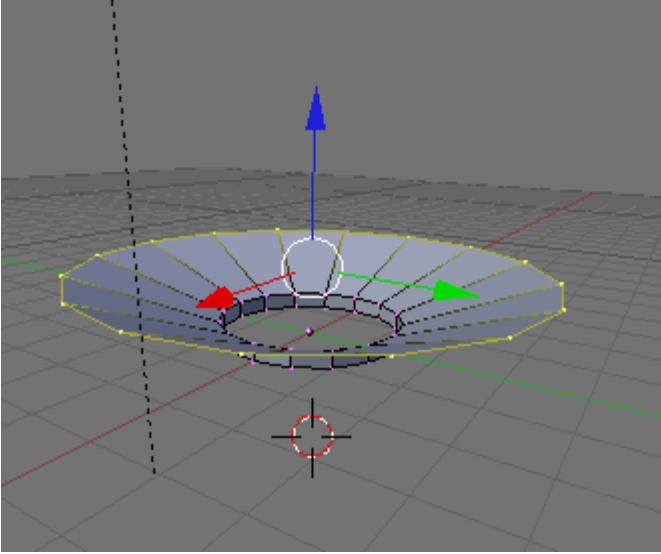

Note: your side viewport should be in wireframe mode. If it is not, press the ZKEY. It is usually best to model in wireframe.

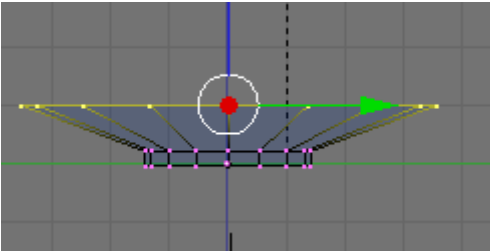

In the side view, press the EKEY and extrude the edges up a bit as shown below.

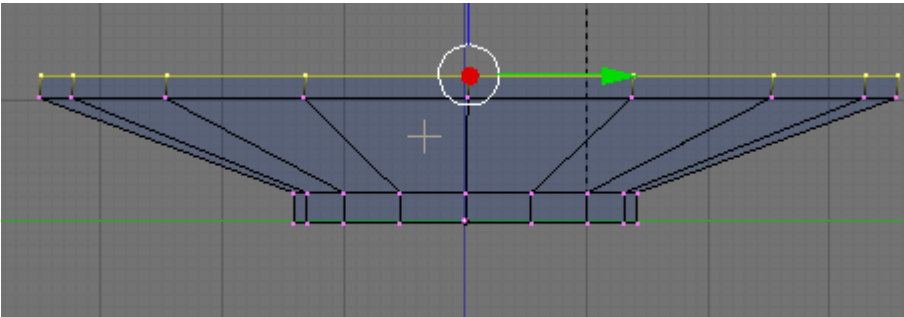

Press the EKEY (Extrude) and extrude the edges again up a bit as shown below.

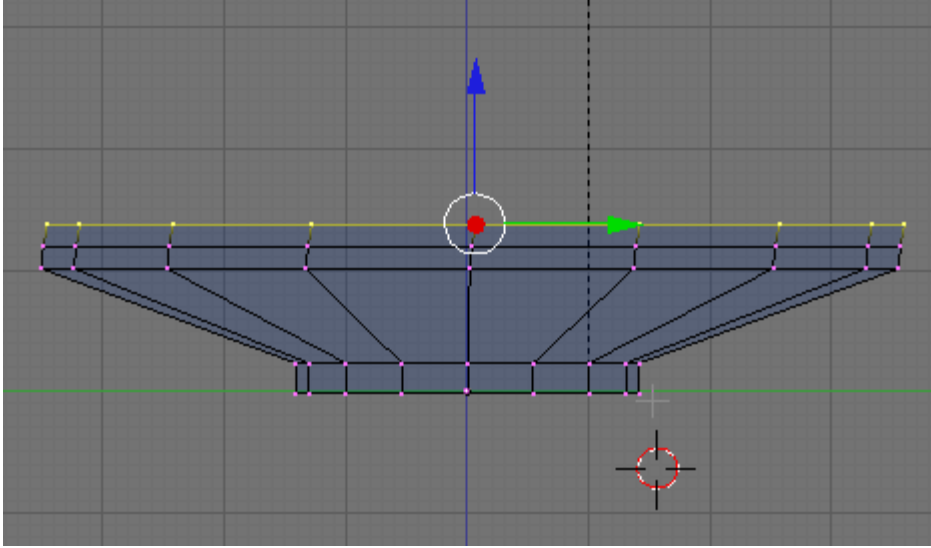

Switch to Top View (NUM7). Press the SKEY (Scale). Scale the vertices down a bit as shown below.

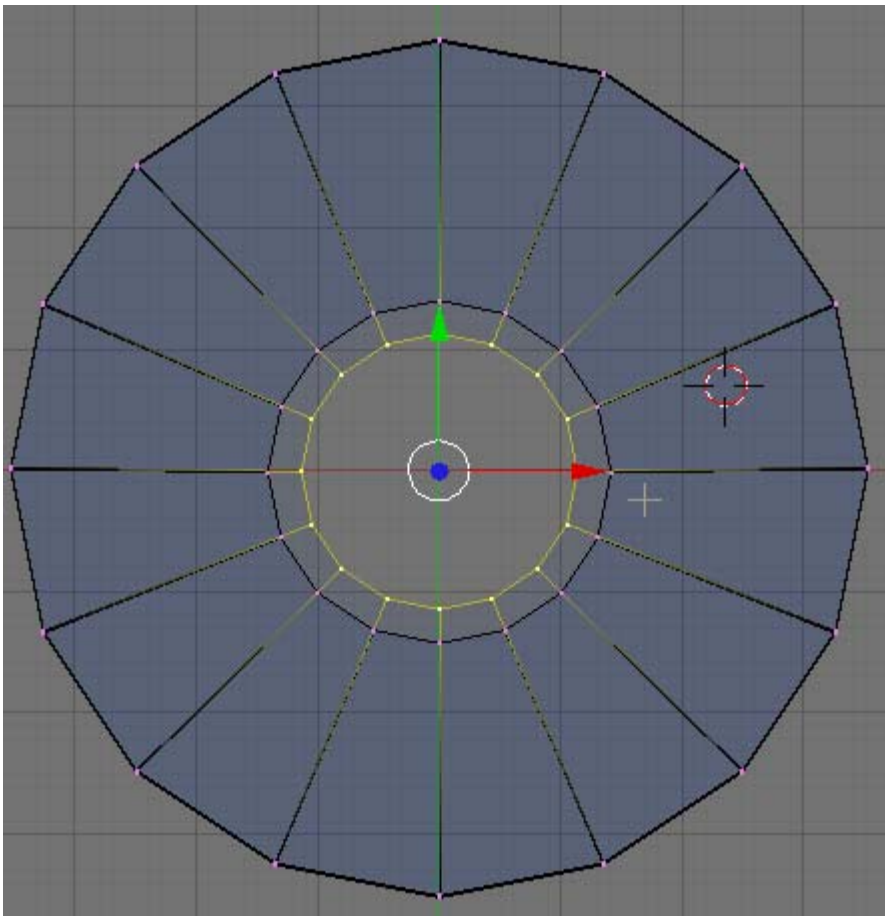

Switch to Side View (NUM3). LMB click the Blue Transform Widget arrow and move it down a bit as shown.

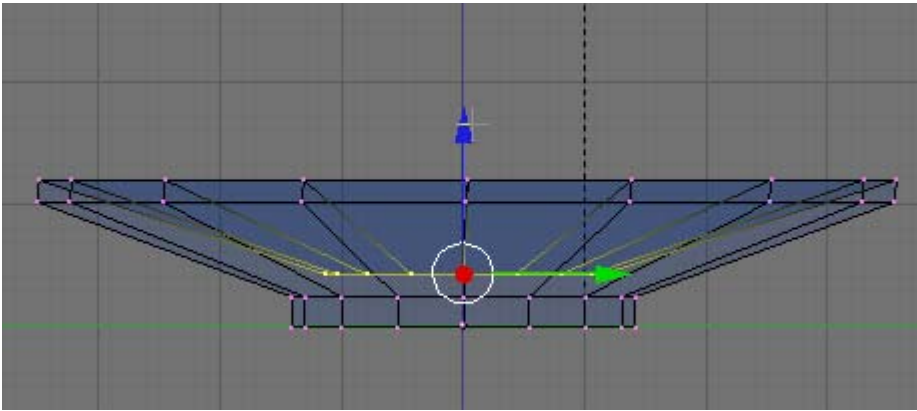

Press the EKEY (Extrude) and extrude the edges up a bit as shown below.

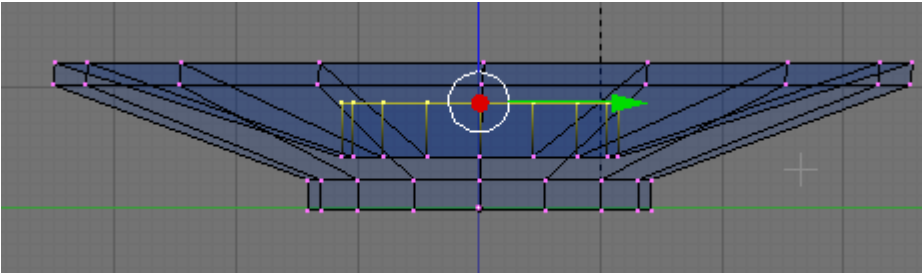

Press the EKEY (Extrude) and extrude the edges again a bit as shown below.

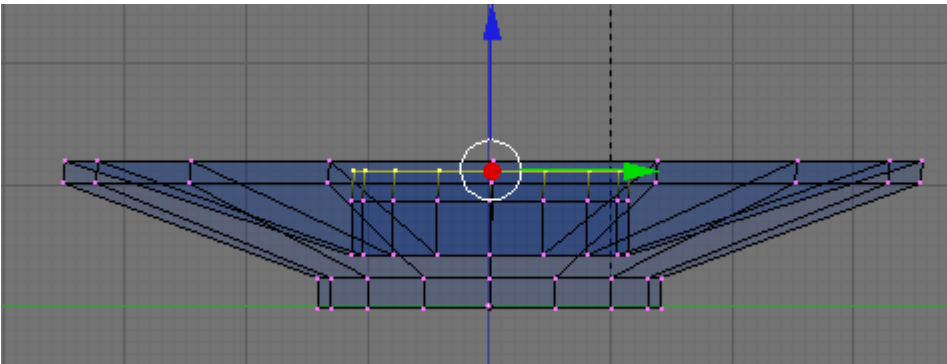

Switch to top View (NUM3). Press the SKEY (Scale) and scale down the vertices as shown.

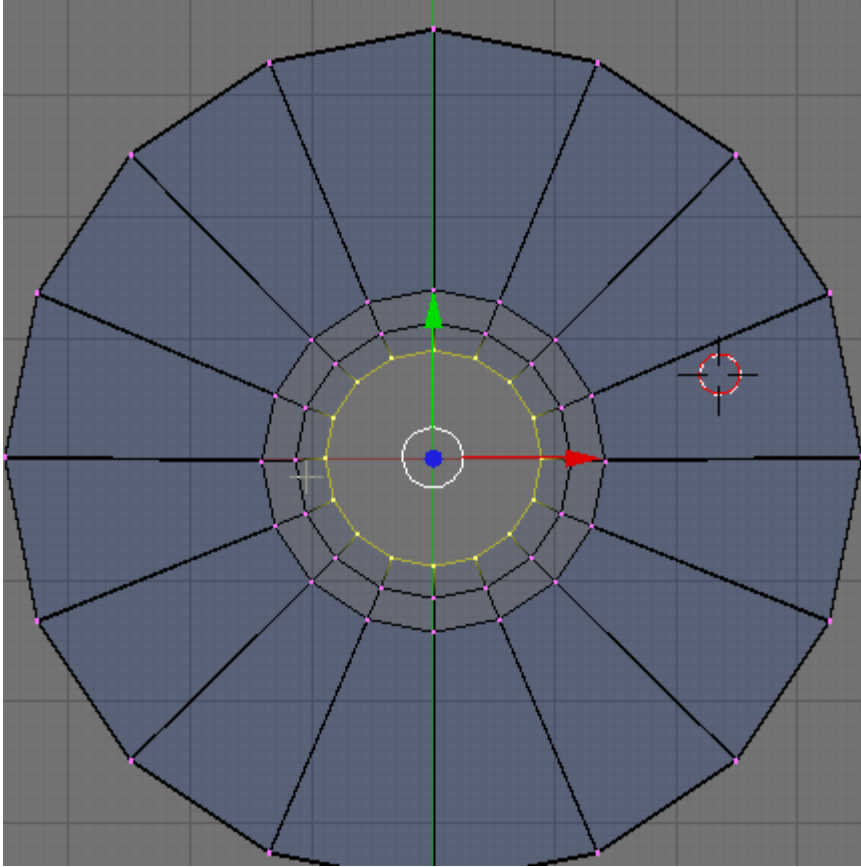

Switch to Side View (NUM3). LMB the Blue Transform Widget arrow and move it down just a small bit as shown in the two images below.

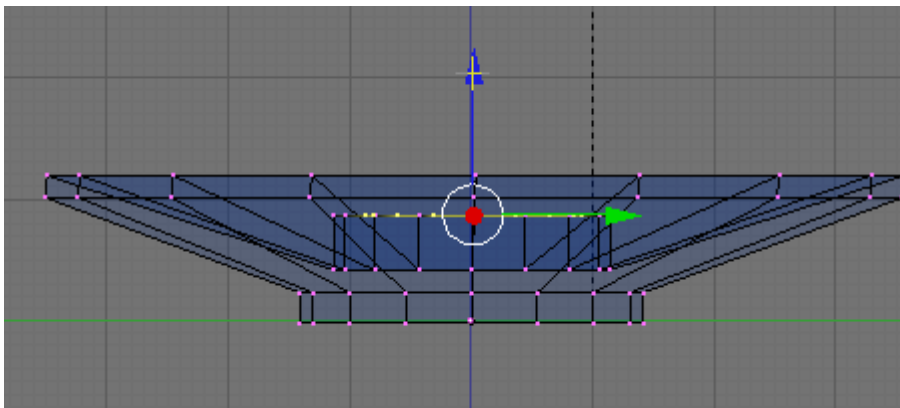

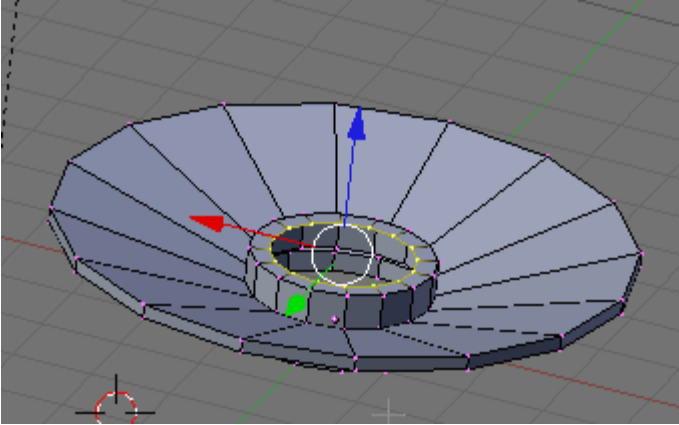

Press the EKEY (Extrude) and edge extrude down the edges as shown below.

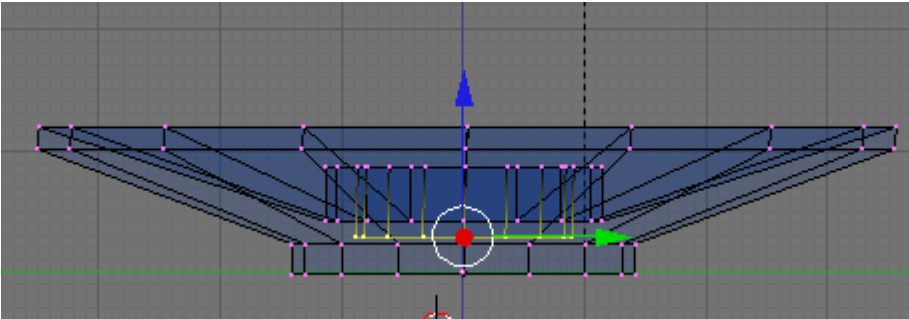

Press the AKEY to deselect the vertices. TAB out of Edit Mode. The candle holder at this point should look like below. (Note you can use the UKEY while in edit mode to UNDO any operation and can undo back a number of steps).

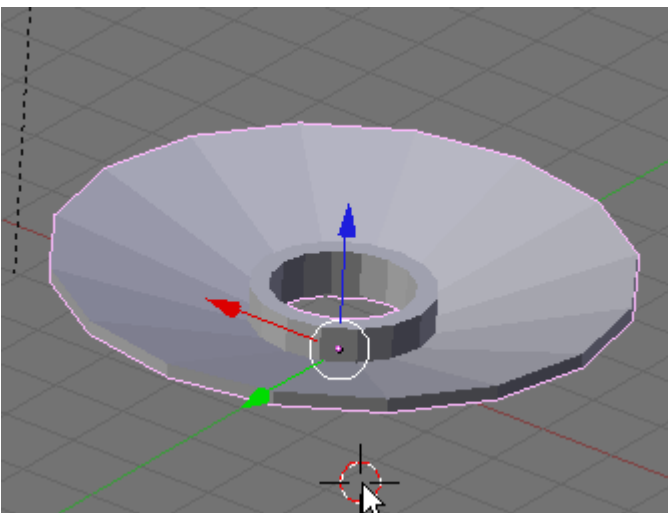

Save your file F2.

We will now smooth out the candle base. Press F9 (Editing) if not already selected.

In the Modifier Panel press the Add New Button and select SubSurf from the dropdown box.

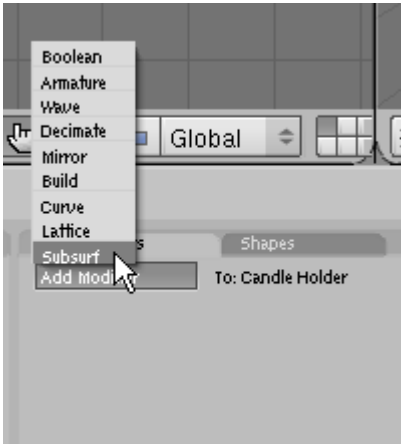

In the SubSurf controls set the Levels to 2 and the Render Level to 2

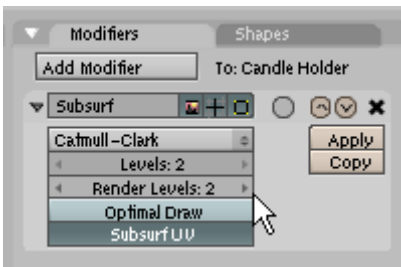

In the Link and Materials Panel, press the Set Smooth Button (activating it).

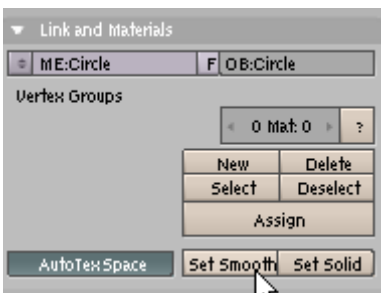

Press the NKEY (Transform Properties) In the Transform Properties Panel name this object Candle Holder. It is good modeling practice to name all of your objects.

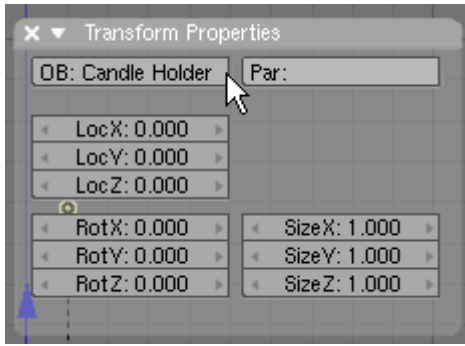

Using Blender's Sub Surf and Set Smooth tools we now have a nice candle holder.

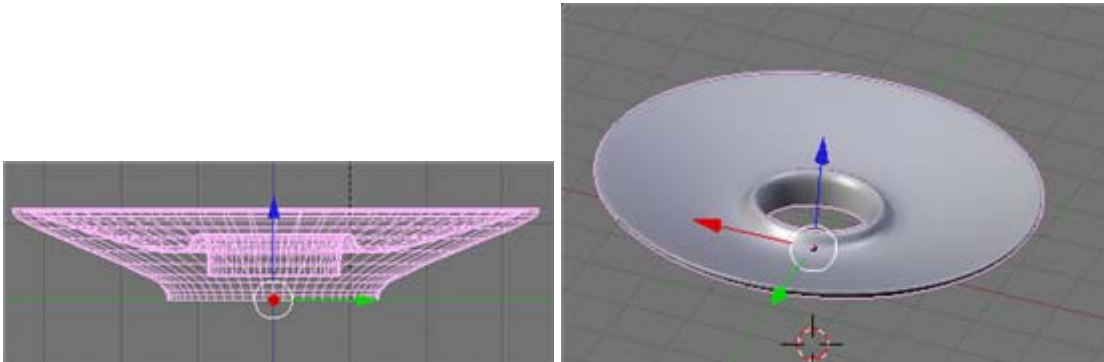

Save your file CTRL-W.

Switch the RIGHT viewport to Camera View (NUM0). The camera view should be close to centered. Switch the LEFT viewport to top view (NUM7). RMB click select the camera object and move it (GKEY) if necessary.

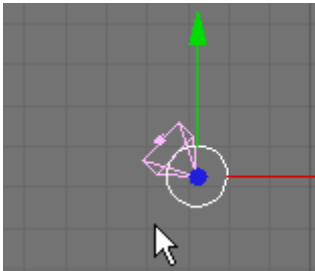

You may have to move the camera in front or side view as well (you may even have to rotate it) to get something like the camera view below.

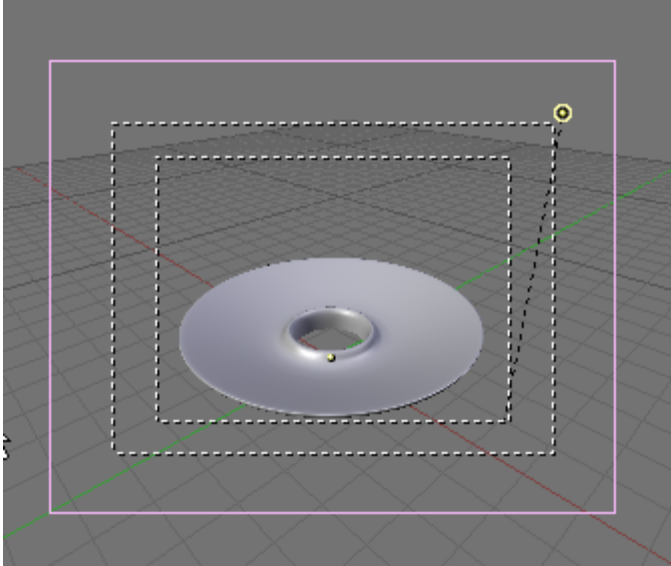

Switch the RIGHT viewport to Side View (NUM3). Select the lamp object (small yellow circle), press the GKEY and move it to above the camera.

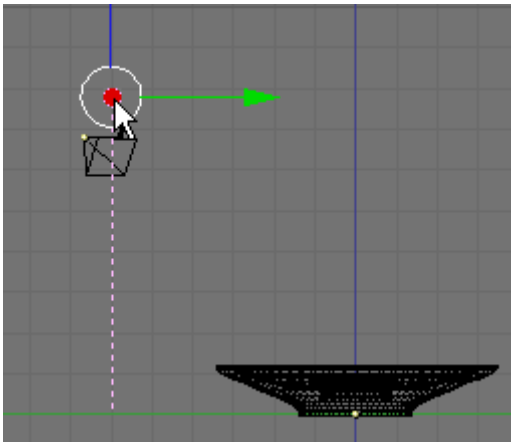

Switch to Top view (NUM7) and move the lamp to above the camera.

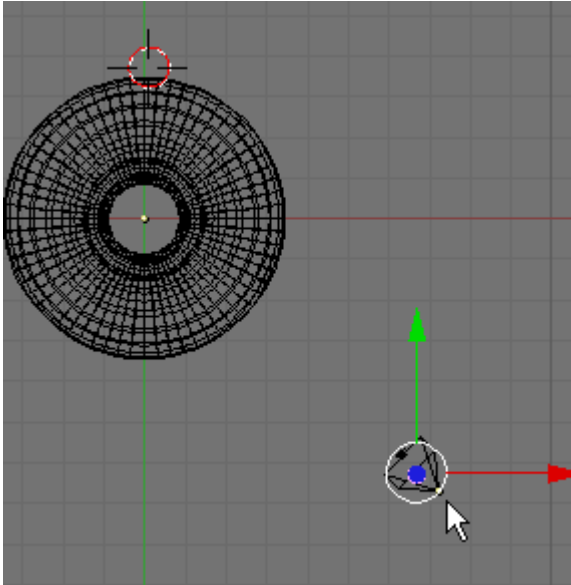

With the lamp selected, Press F5 (Shading). In the Lamp Panel raise the Energy level of the lamp to 1.75

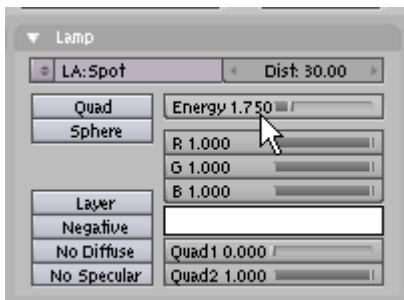

Press F10 (Scene). In the Format Panel Press the Preview preset button (This sets the output size to 640 x 480 at 50% or 320 x 256 pixels)

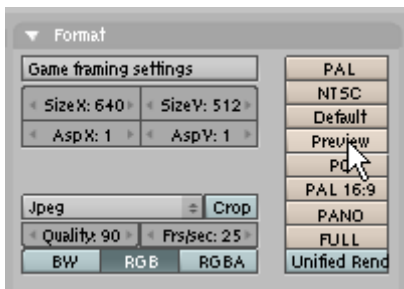

In this same Format Panel make sure the output file type is set to JPEG.

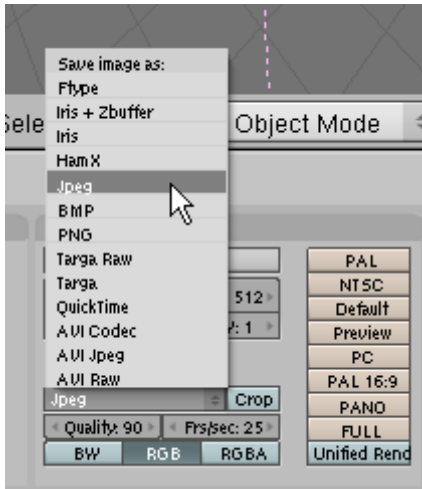

In the Render Panel press the Render button or press F12.

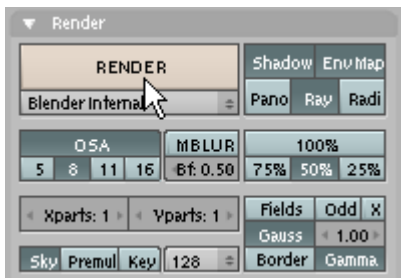

The Candle Holder is rendered in a separate buffer window.

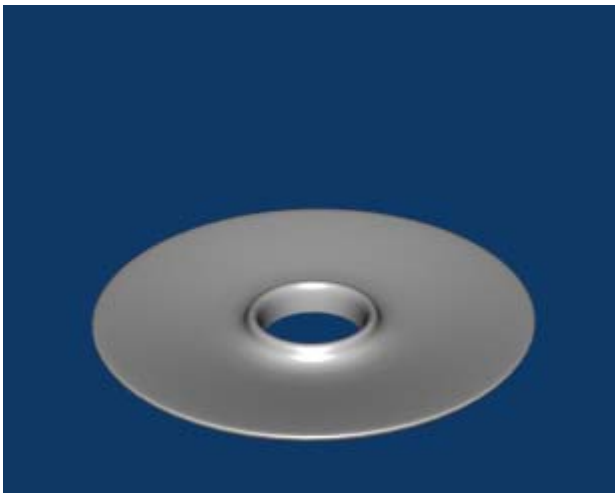

To save this image as a file, press F3. Navigate to the directory in which you would like to store the file then type in a name. Here I have called the file CandleHolder.jpg. (NOTE: MAKE SURE YOU ADD THE FILE EXTENSION.JPG). Finally, press the Save JPEG button.

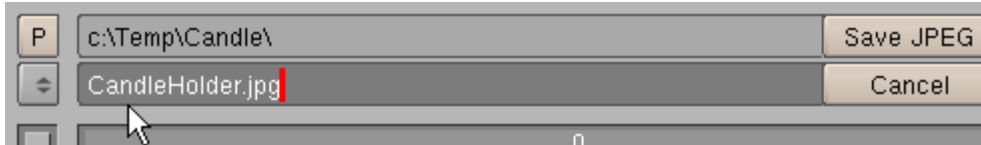

The jpg image file will be placed in whatever directory you have chosen.

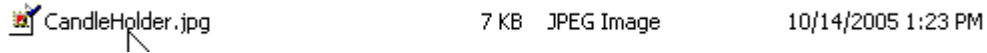

Save your file CTRL-W.

Next we will create a material for the Candle holder. With the **Candle holder selected** press F5 (Shading).

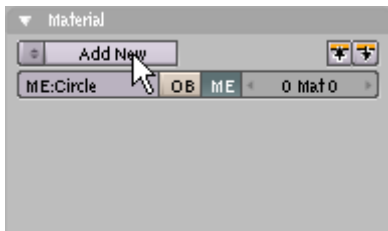

In the Material Panel Press Add New. This will display the material buttons (Note: If your object has ever had a material attached to it in the past the “Add New” will not appear. Pressing F5 will go straight to the Material Buttons.)

In the Material Panel you will see the Color (COL) button is activated and the Red, Green and Blue color sliders are set to a light grey color which is the default. Adjust the color sliders to the following values:

- Red: 1
- Green: .895
- Blue: .404

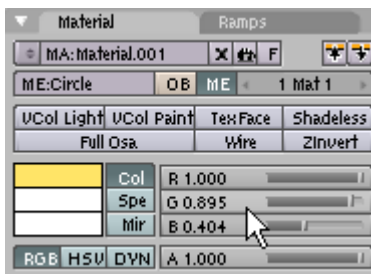

Note in camera view that the Candle holder is a yellowish gold color.

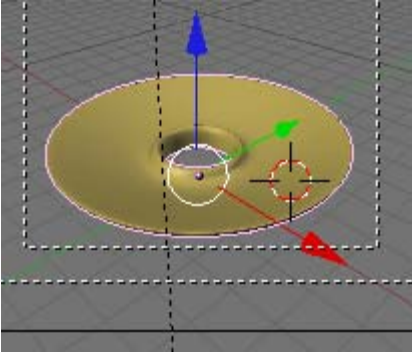

The Color (COL) setting affects the diffuse color of the object (the general color). Press the SPE button (Specular) and adjust the color sliders to the following values:

Red: 1

Green: .955

Blue: .699

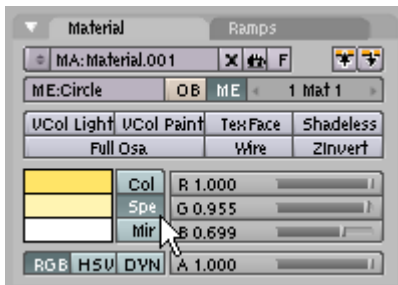

You will not notice much difference in the camera view. The Specular (SPE) color setting affects the color of the specular highlights of the object. We can only see those highlights when the object is rendered.

Note: The Mirror (MIR) button is used to set the color used by special textures to fake mirror reflections. We will not be using this so we will accept the defaults).

Click on the Shaders Tab to expose the panel. Blender uses a separate shader when rendering diffuse and specular colors. Leave the Lambert Diffuse Shader st at 1. Adjust the Degree of Specularity (Spec) in the Cook Torr Specular Shader to 1 and the Hardness to 255.

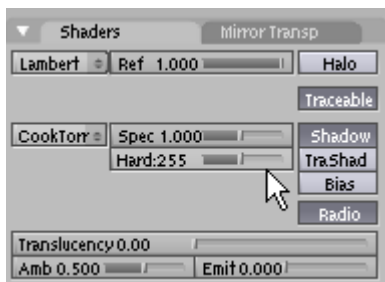

We should now have a nice gold material applied to our candle holder. Press F12 (Render).

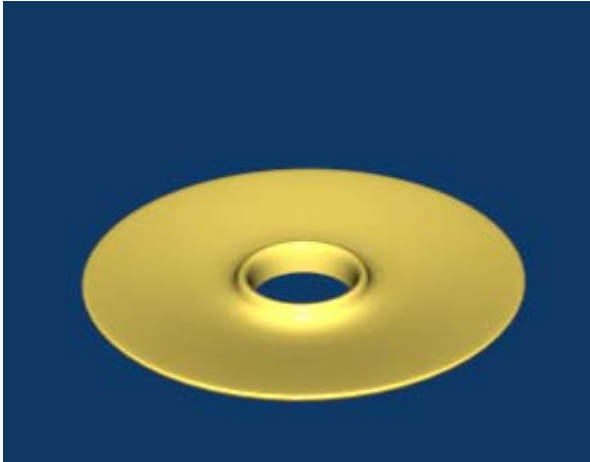

If you want to save this as a JPG file press F3 (remember to add the .jpg file extension to the file name).

Save your file CTRL-W.

We will now model the candle itself. Switch the left side viewport to Top View (NUM7). Zoom in a bit and press the AKEY deselecting anything that might be currently selected. Place your 3D cursor in the center of the candleholder. We want to create a separate object so we MUST start in Object Mode.

Press Space / Add / Mesh / Cylinder. Choose 16 segments.

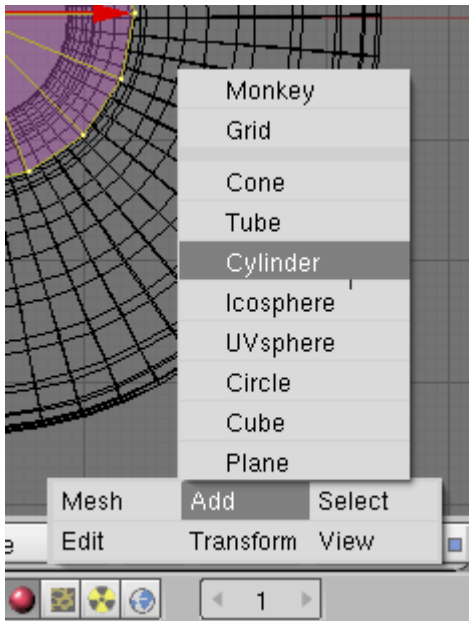

The cylinder mesh is created and placed in the center of the candle holder and is automatically in edit mode with all of the vertices selected.

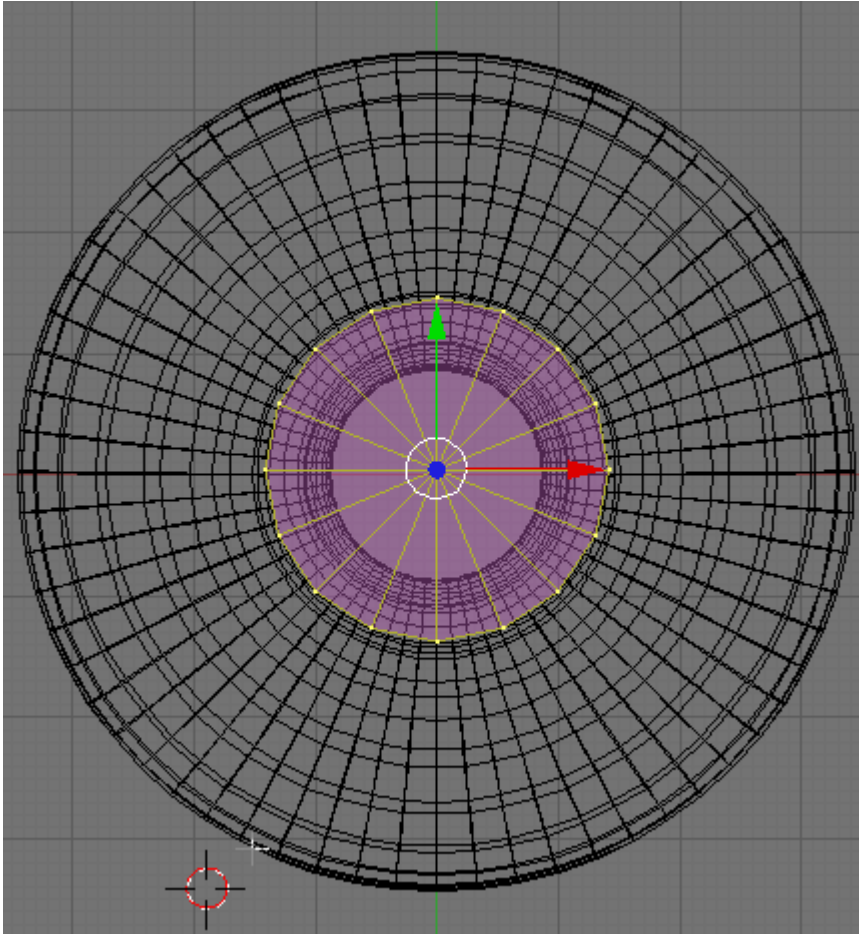

Press the SKEY (Scale) and Scale the cylinder down to fit the hole in the candle holder.

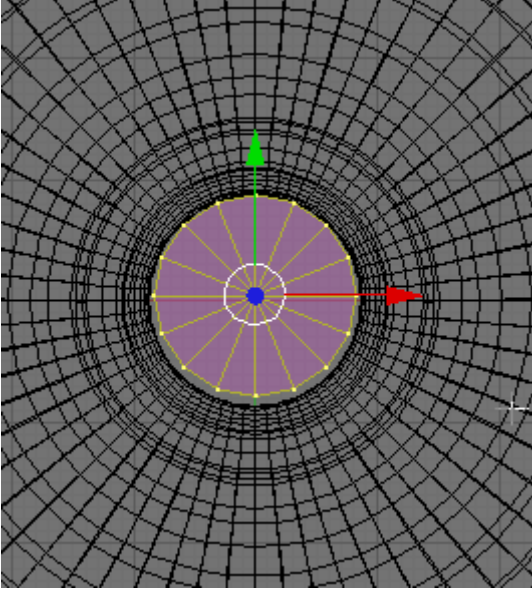

Switch to side view (NUM3). Notice that the cylinder is below the candle holder. LMB the Blue Transform Widget arrow and move it up into the candle holder as shown.

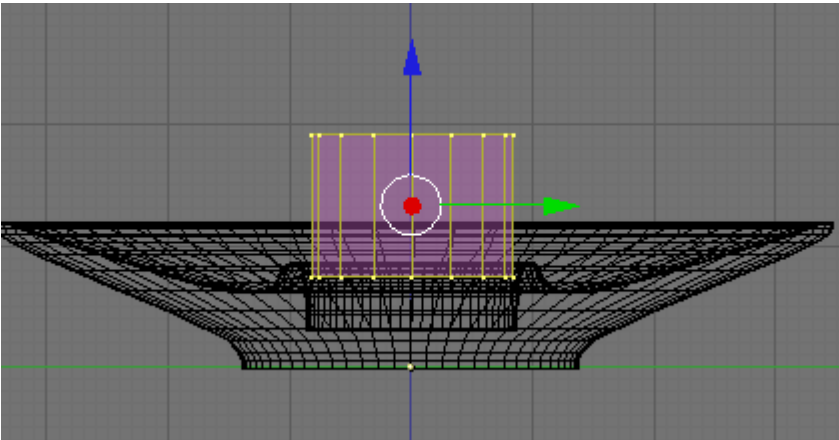

Note: You may have to use the other Widget arrow to adjust its position so it is in the center of the candle holder hole.

Press the AKEY to deselect the vertices. Zoom out a bit and press the BKEY (Box Select) and box select the top vertices.

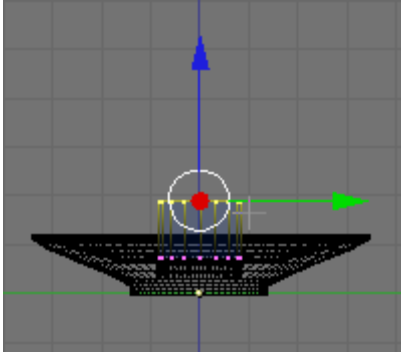

LMB the Blue Transform Widget arrow and drag the vertices up as shown.

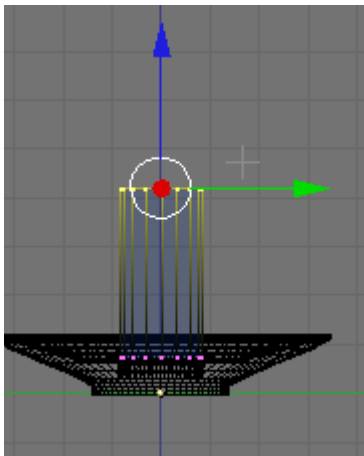

Switch to Top View (NUM7) Press the AKEY deselecting the vertices. Zoom in on the center top of the cylinder. With your RMB select the single center vertex on the top.

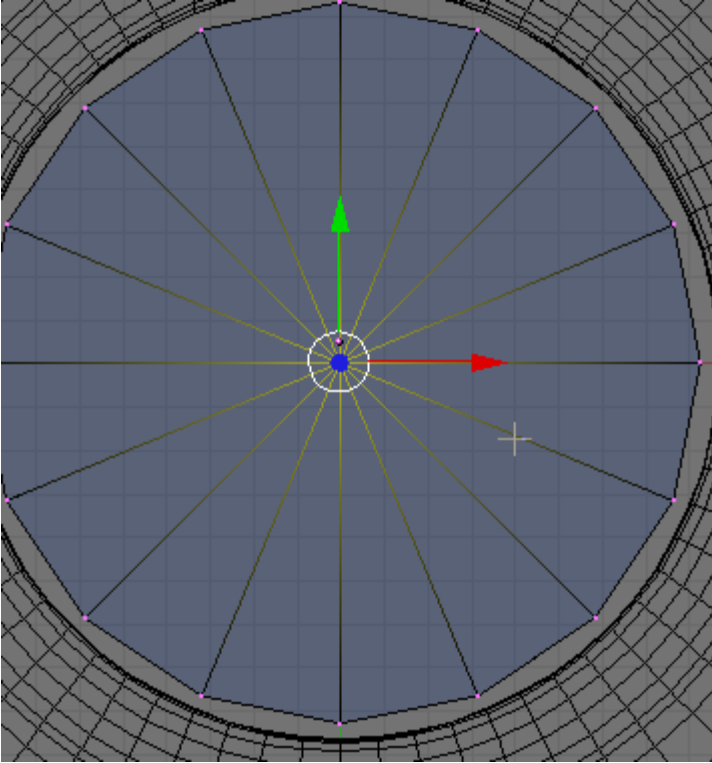

Switch to side view (NUM3).

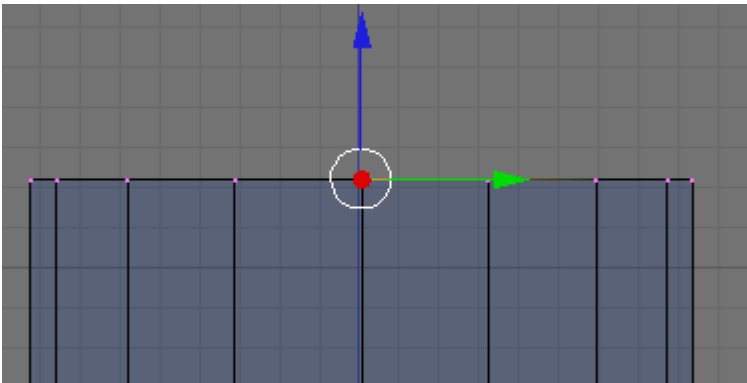

LMB click the Blue Transform Widget arrow and move the single vertex down a bit as shown to create a depression in the candle.

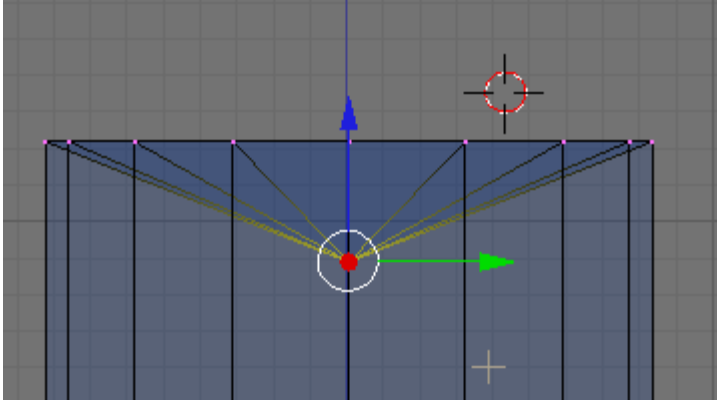

Press the AKEY to deselect the vertex. Zoom out a bit to see the whole candle in side view. Press the AKEY again to select all of the vertices. Press F9 (Editing) if not already showing. In the Mesh Tools Panel press the Subdivide button ONCE. This will create twice as many faces on the object and will help a bit when rendering the diffuse color.

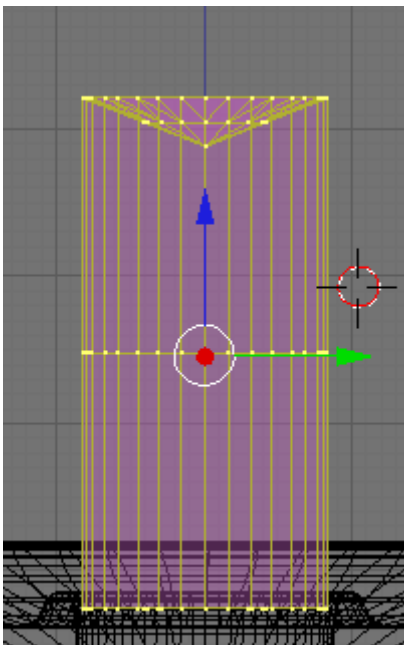

Press the AKEY to deselect the vertices. Press TAB to exit Edit Mode and enter Object Mode. Press the NKEY (Transform Properties) and name this object Candle.

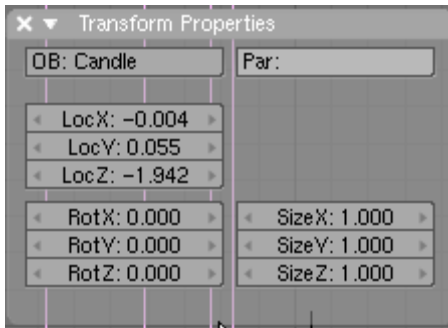

We will not use Sub Surf on the candle but In the Link and Materials panel press the Set Smooth button.

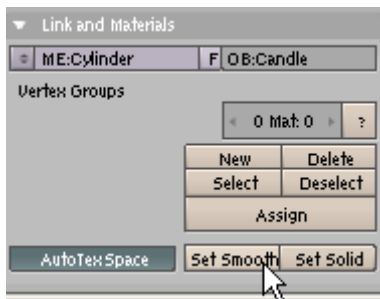

With the candle selected and in OBJECT MODE zoom out in the side view to see the entire candle and holder. Notice that the Transform Widget is now located somewhere below the candle.

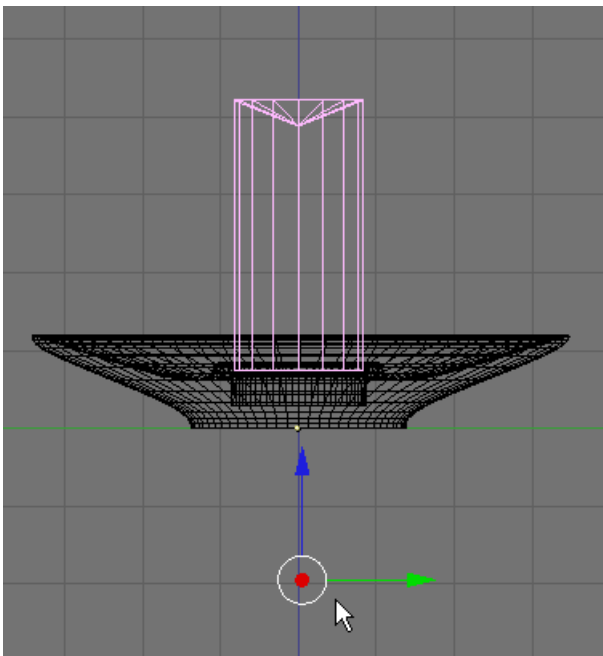

Turn off the Transform Widget. (hand icon)

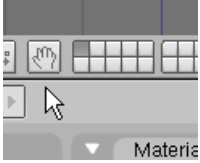

Note that there is a small “dot” where the transform widget used to be. This is the original object’s (mesh cylinder) “origin center”. UNFORTUNATELY, when you move an object in Blender the object’s origin is left behind in its original place.

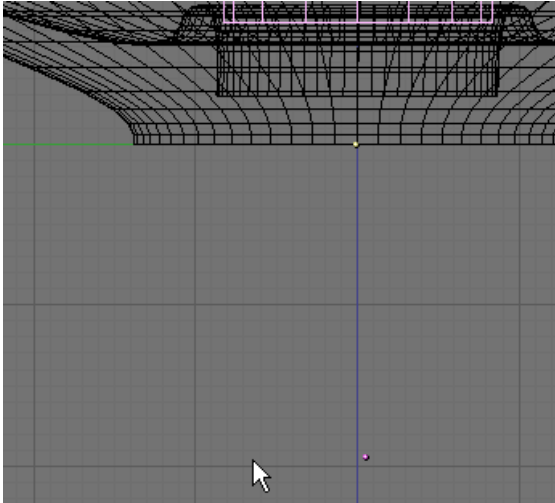

With the candle selected, in the Ink and Materials panel press the Center New button. This will move the origin center “dot” to the center of the new candle position.

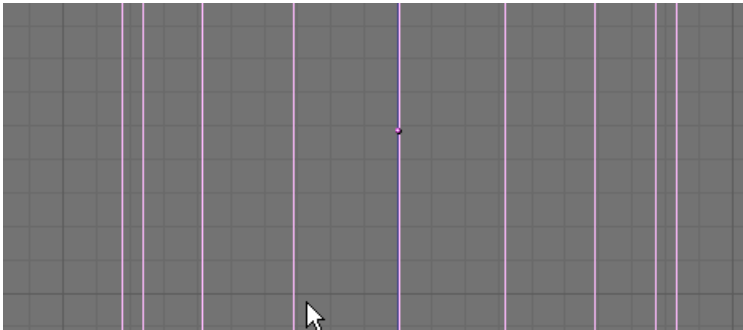

Press F5 (Shading) and in the Material Panel press the Add New Material Button.

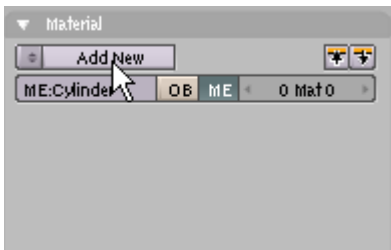

In the Material Panel set the Diffuse Color sliders to;
Red: 1
Green: .492
Blue: .364

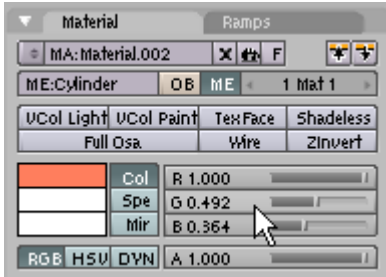

In the Shaders panel set the degree of Specularity to 1 and the hardness to 50.

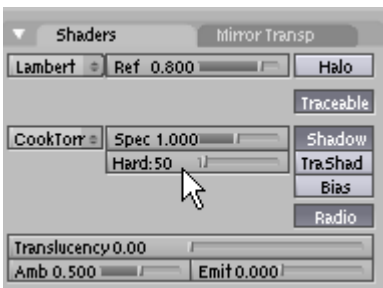

Is a red/orange color for the candle.

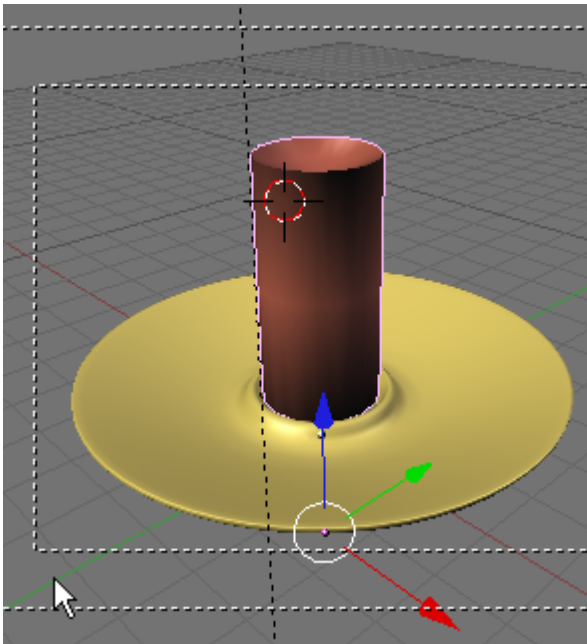

Save your file CTRL-W.

We will now model the candle wick. Switch the left viewport to Front View (NUM1).

Press the AKEY deselecting anything that might be currently selected. Place your 3D cursor to the right of the candle. We want to create a separate object so we MUST start in Object Mode.

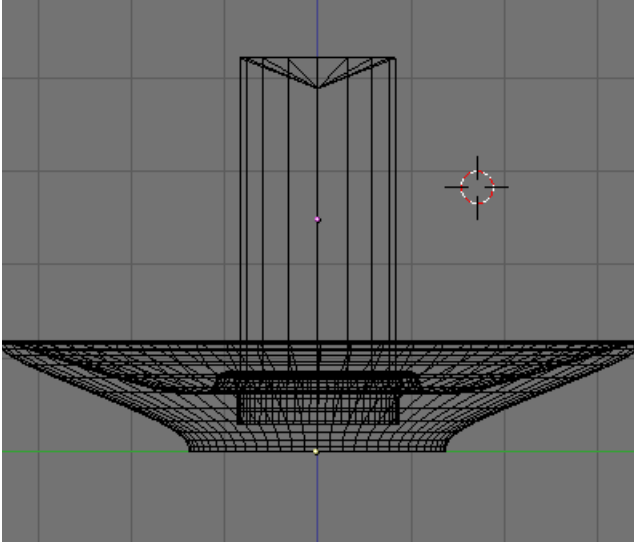

Press Space / Add / Mesh / Cube.

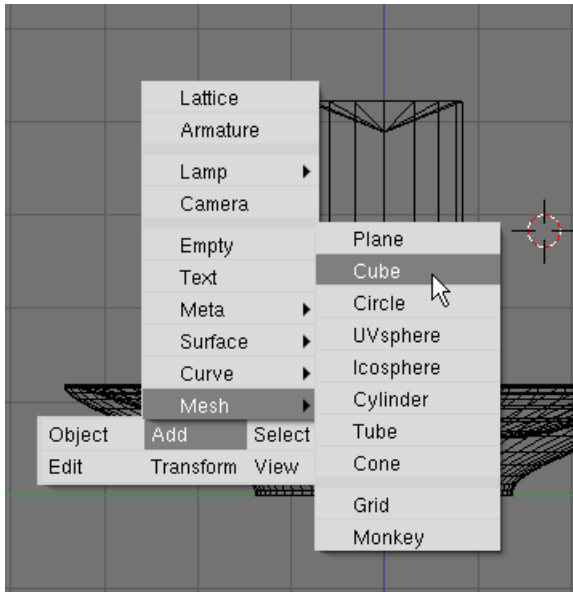

Press the SKEY and scale down the cube to very small as shown.

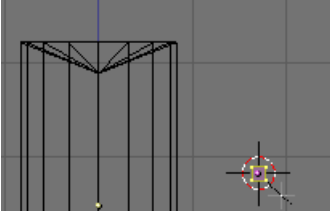

Press the GKEY(Grab) and move the cube to the top of the candle as shown.

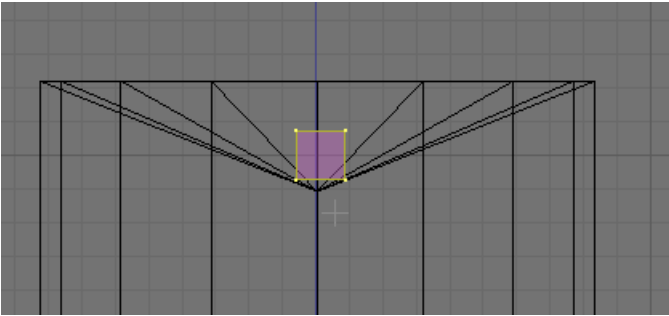

Switch to top view (NUM7) and Grab (GKEY) the box and center it in the candle.

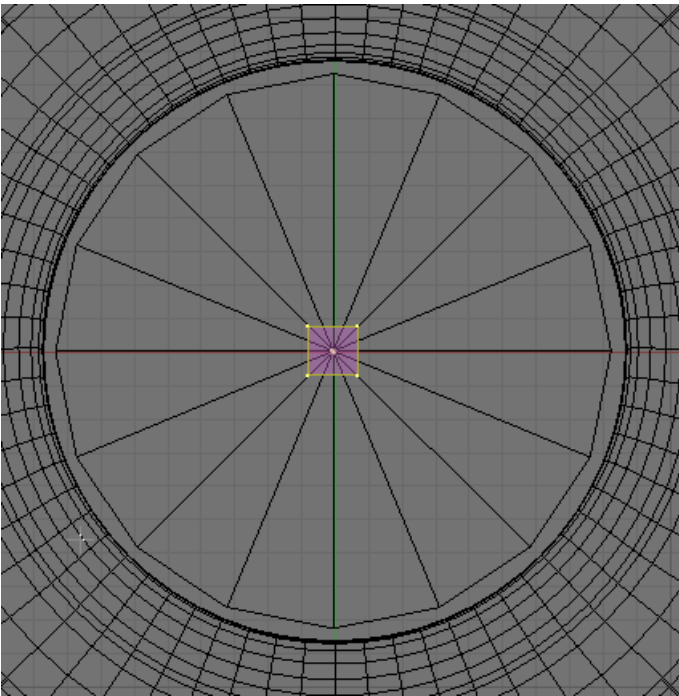

Switch back to side view (NUM3). Press the SKEY (Scale) and scale the cube even smaller as shown.

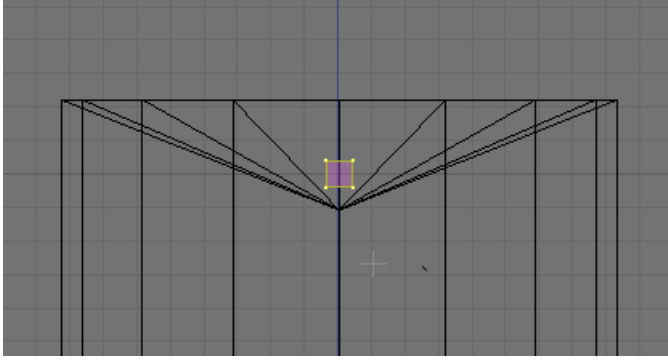

Press the AKEY to deselect the vertices. Box Select (BKEY) the top vertices.

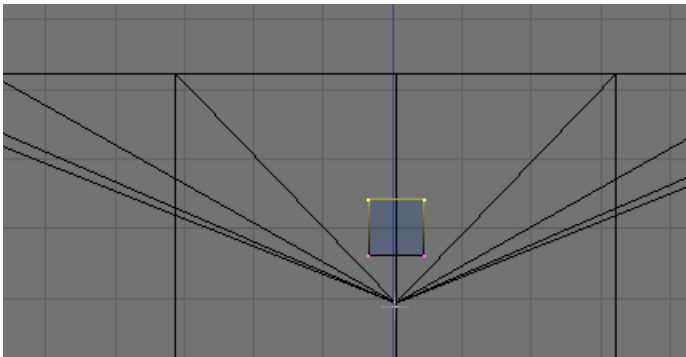

Turn back on the Transformation Widget. The widget will appear in the center of the selected vertices.

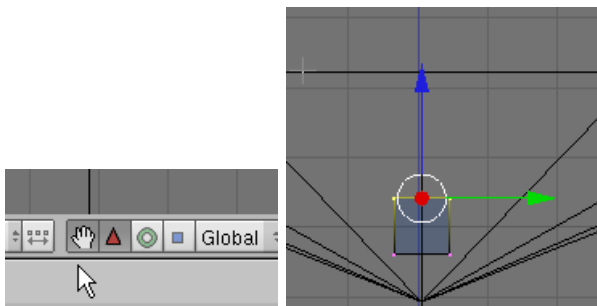

LMB the Blue Transform Widget arrow and move the vertices up as shown.

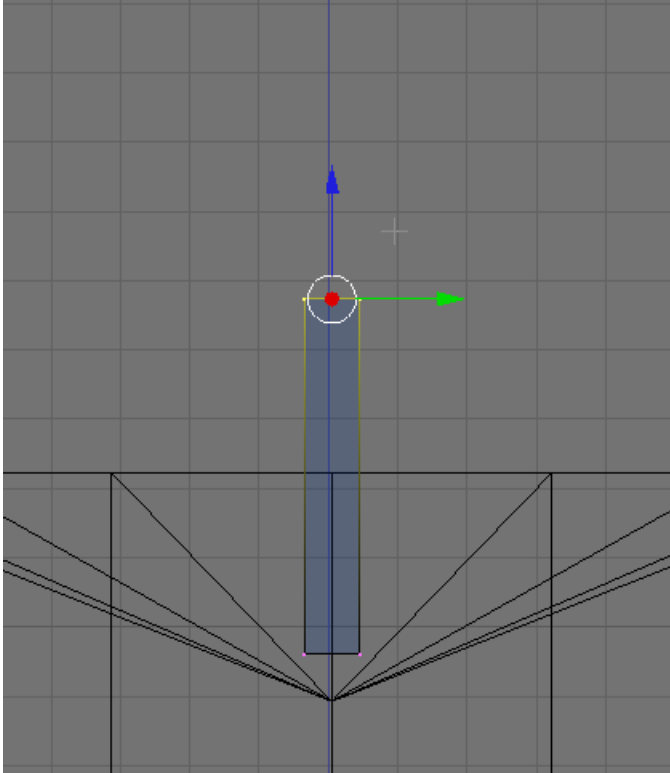

Press the AKEY to deselect the vertices. In the Modifier Panel press the Add New button and select the SubSurf modifier from the dropdown list.

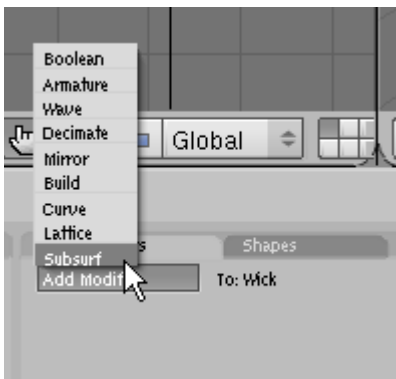

In the SubSurf controls set the Levels to 2 and the Render Levels to 2.

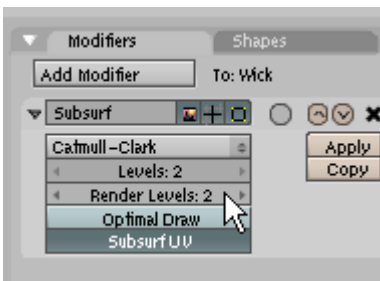

Press TAB to exit Edit Mode. Press the GKEY (Grab) and move the wick lower into the candle.

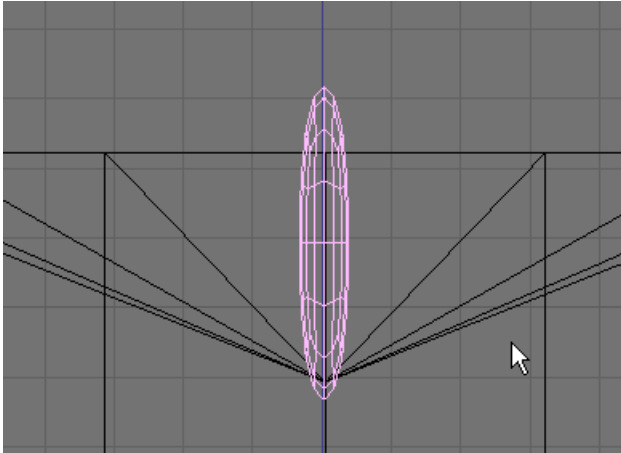

Press the NKEY (Transform Properties) and name this object Wick.

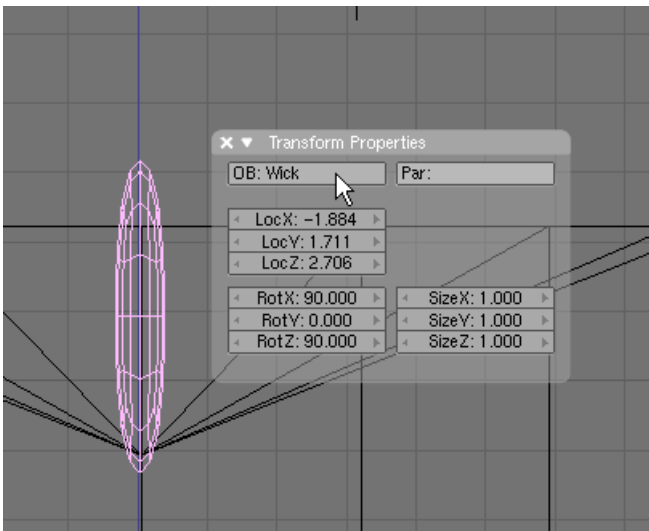

In the Mesh Panel Press the Center New button to move the wicks center origin to its new position.

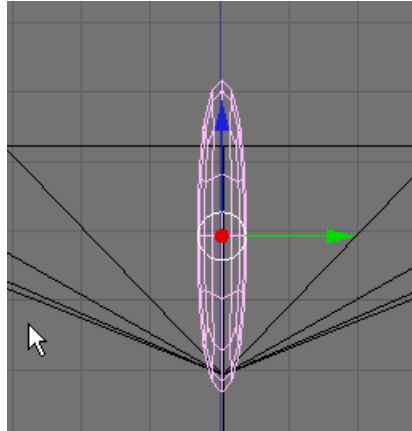
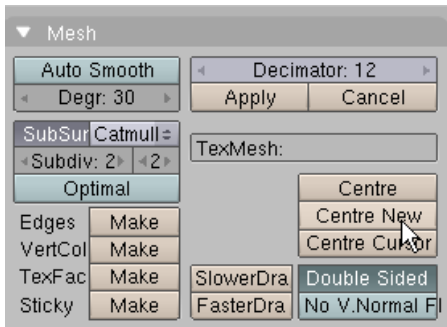

Press F5 (Shading). In the Materials Panel press the “Add New” button. In the Material Panel Set the Color sliders to 0 making a black material.

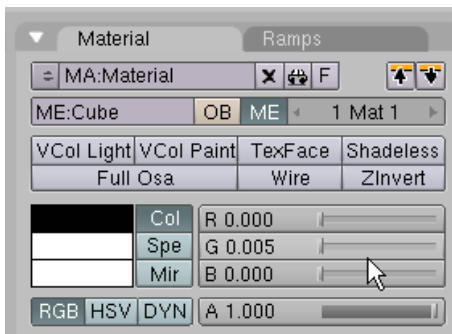

Save your file CTRL-W.

Render the scene F12. To see what it looks like so far.

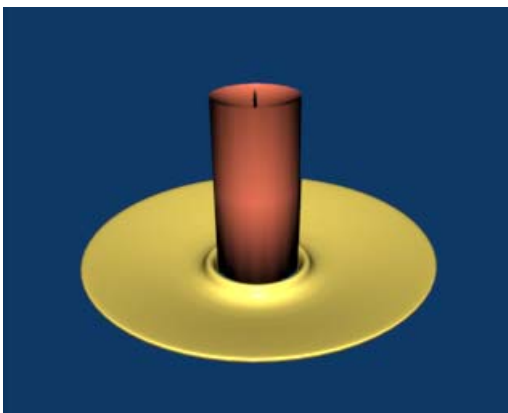

Adjust your camera if you need to get a good image.

We will now place a flame effect on the wick. Switch to top view. Press the AKEY to deselect any objects. Place your 3D cursor in the center of the wick. We want to create a separate object so we **MUST** start in Object Mode.

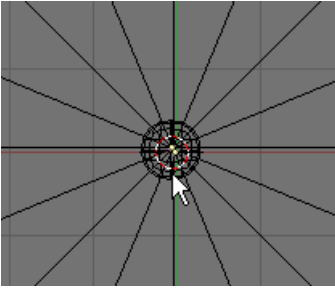

Press Space / Add / Mesh / Circle. Choose 32 vertices.

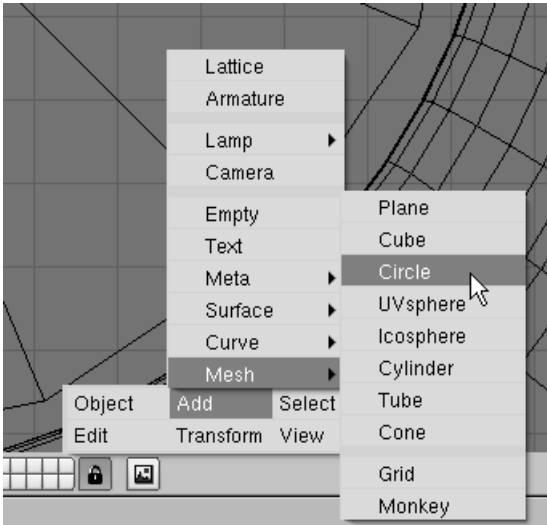

Blender creates the circle mesh and automatically sets it in Edit Mode.

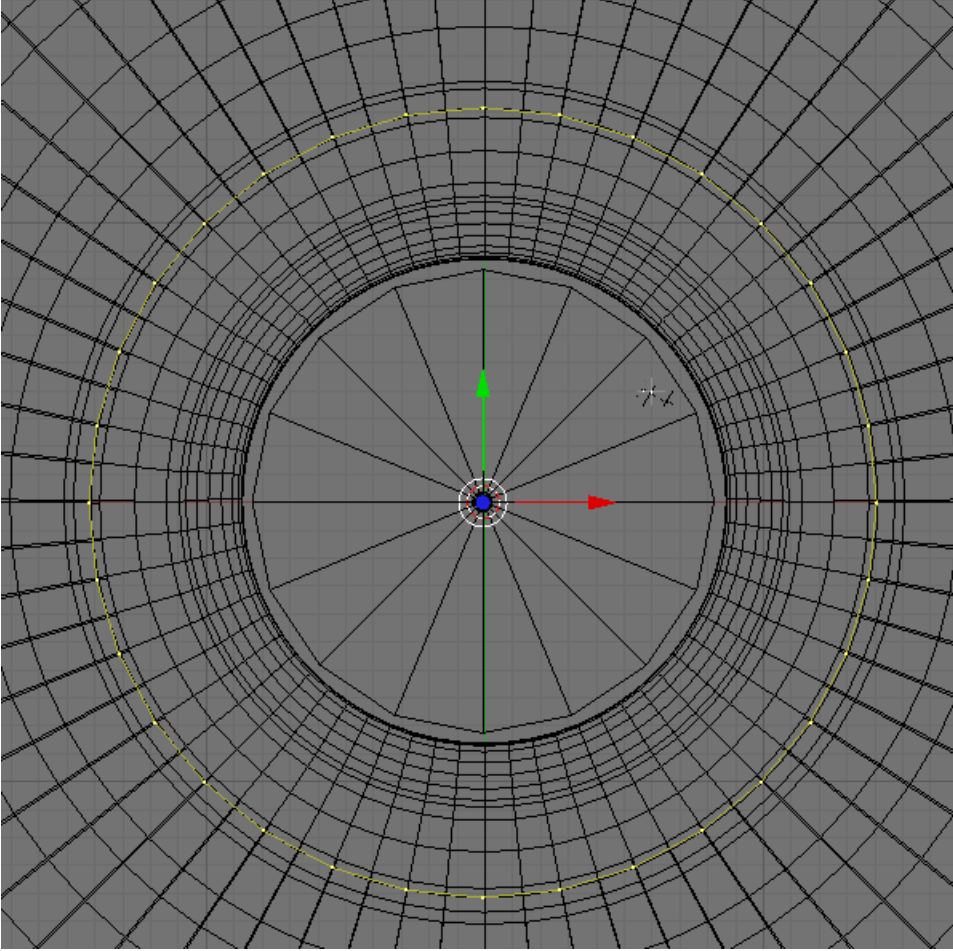

Press the SKEY (Scale) and scale the circle Mesh down to a very small size (a little large than the wick) as shown.

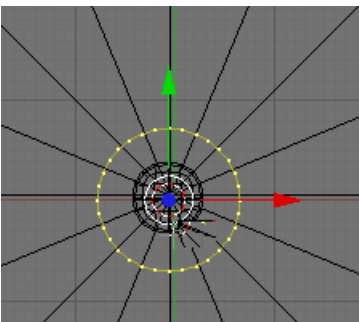

Switch to Side View (NUM3). LMB the Blue Transform Widget arrow and move it up just outside of the candle as shown.

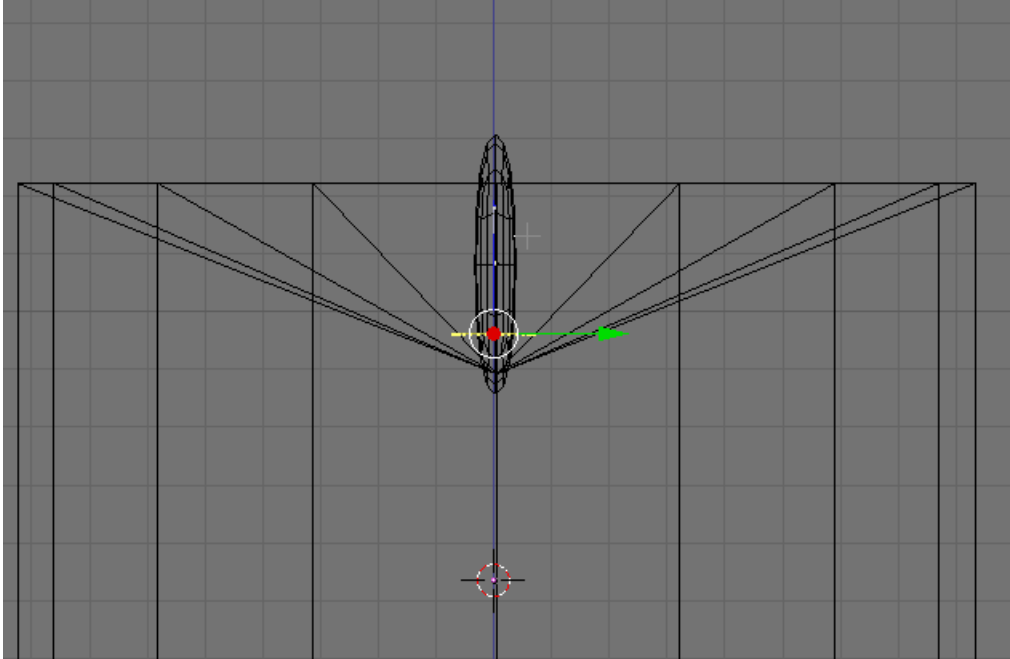

Press the AKEY to deselect the vertices. Press TAB to leave Edit Mode. Press F9 (Editing) and in the Link and Materials Panel press the Center New button to move the object's origin center to the new position.

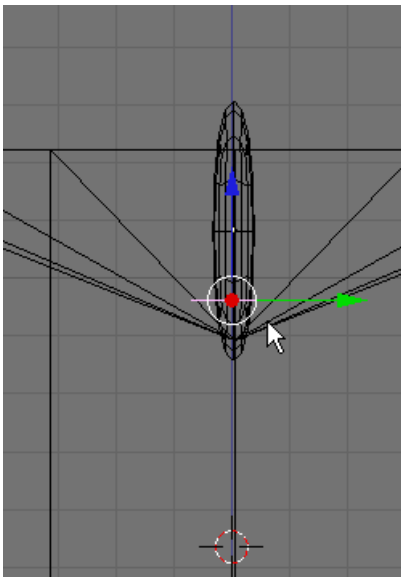

Press F7 (Object) and Click on the Physics Buttons icon.

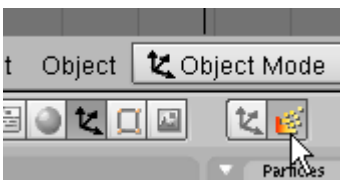

In the Particles Panel press the New Button



In the Particles Panel settings set the Amount to 300 and the Start to -250.

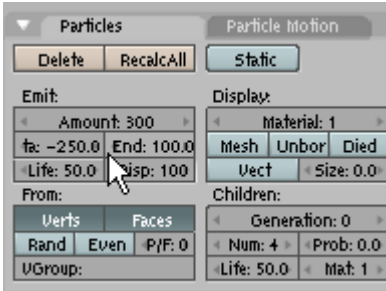

Click on the Particle Motion Tab. In the Particle motion Panel set the Random setting to .007 and the Z Force to .04

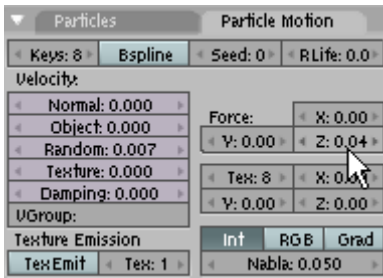

You will see in the side view some particles.



Press ALT-A (Play animation). You will see the animation of the particles from frame 1 to 100. Press ESC to stop.

Press the NKEY (Transform Properties) and name the circle mesh object Particle Emitter.

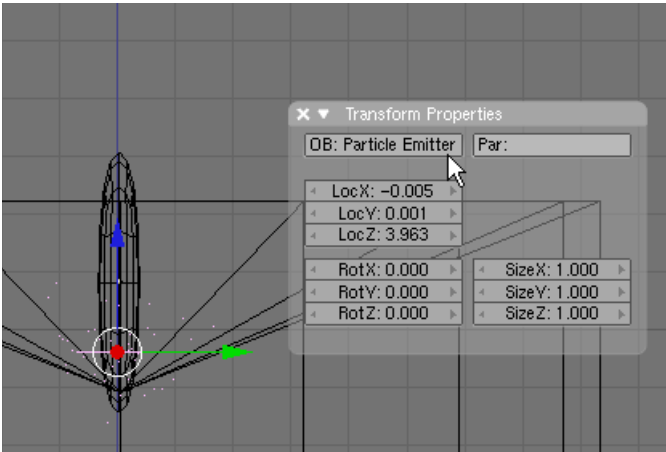

With the Emitter selected, press F5 (Shading). In the Material Panel press the New Material button.



In the Material Panel create a yellowish color by setting the Color sliders to:

Red: 1

Green: .860

Blue: 0

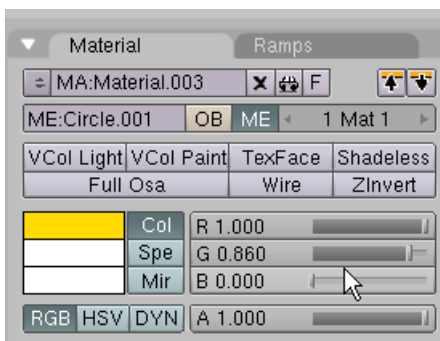

In the Shaders Panel press the Halo button (activating it). Set the Halo Size to 0.6

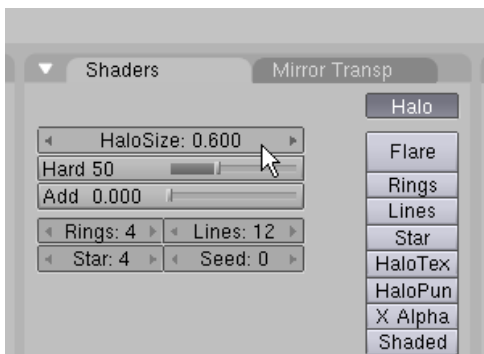

Save your file CTRL-W.

Render the scene F12.

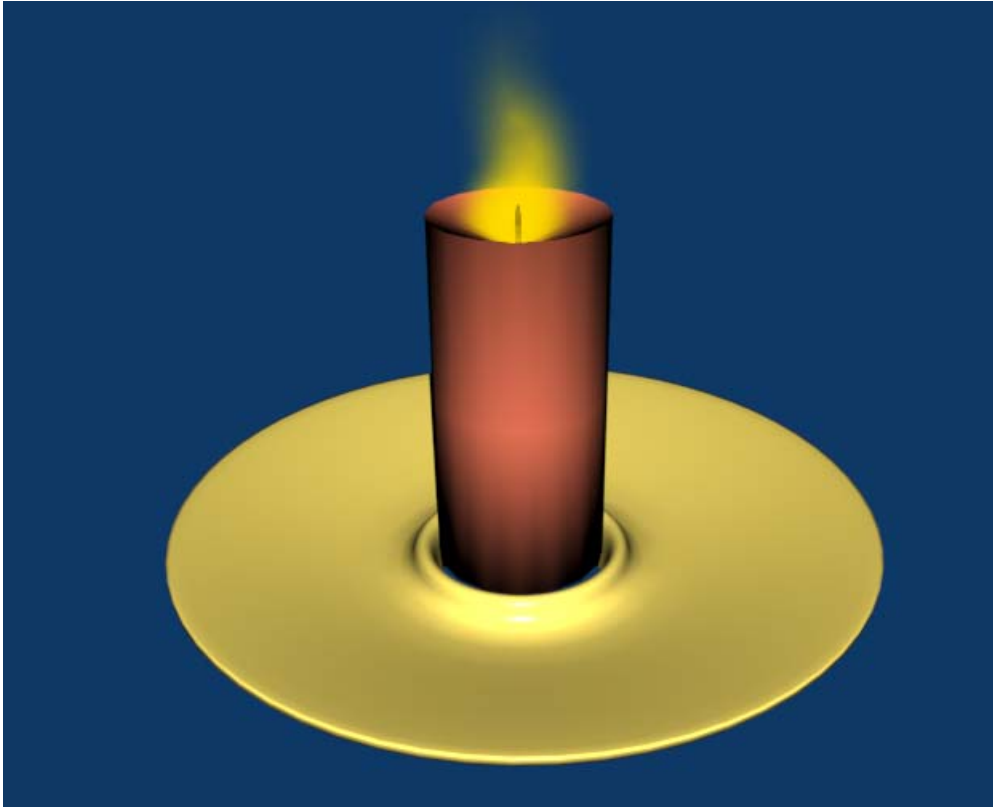

We can refine this flame a bit in the animation. The particles are set to emit for 100 frames and each particle has a life span of 50 frames.

Change the view in the right viewport to the IPO Editor by pressing on the windows button (on the far left of the viewport) and choosing IPO Curve Editor.

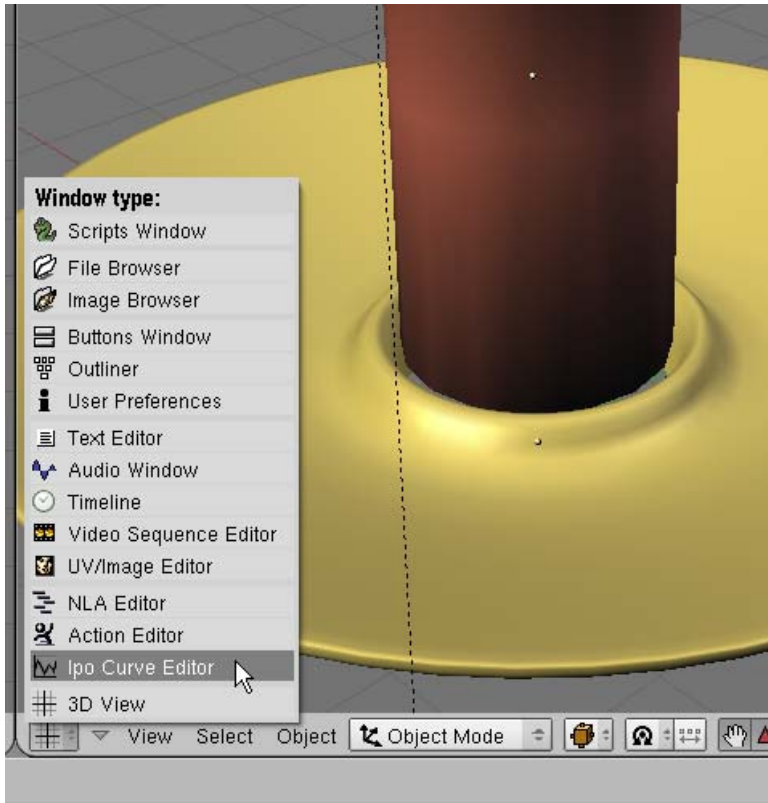

The IPO Curve Editor is a graph that allows you to alter the manner in which objects are animated. On the right of the display are a series of “channels” and on the left is a graph showing time (horizontally) and intensity (vertically).

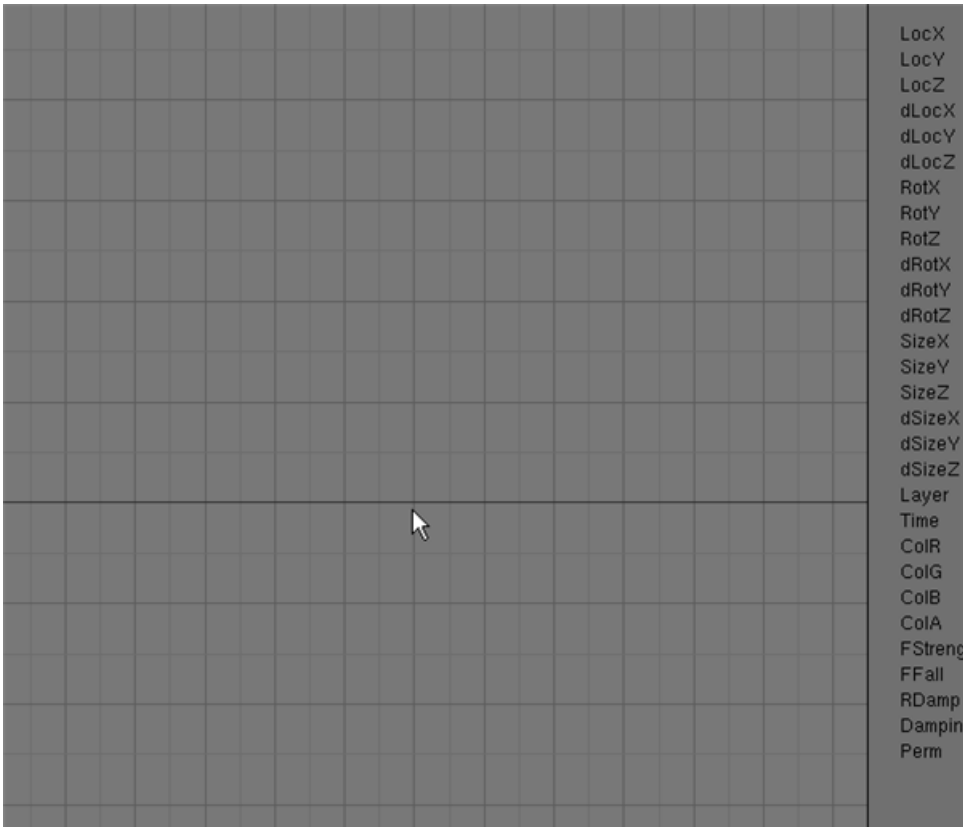

Change the focus of the IPO Window from Object to Material with the dropdown box.

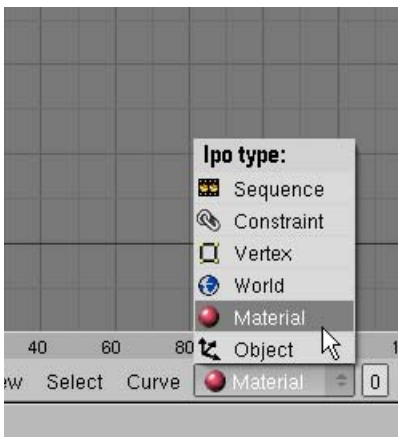

Click on the ALPHA (Transparency) channel. This controls the transparency of the yellow material we applied to the Emitter Particles.



With the Alpha Channel selected, hold down the CTRL key and LMB click TWICE anywhere on the graph. This will create a curve for the Alpha Transparency with two control vertices.

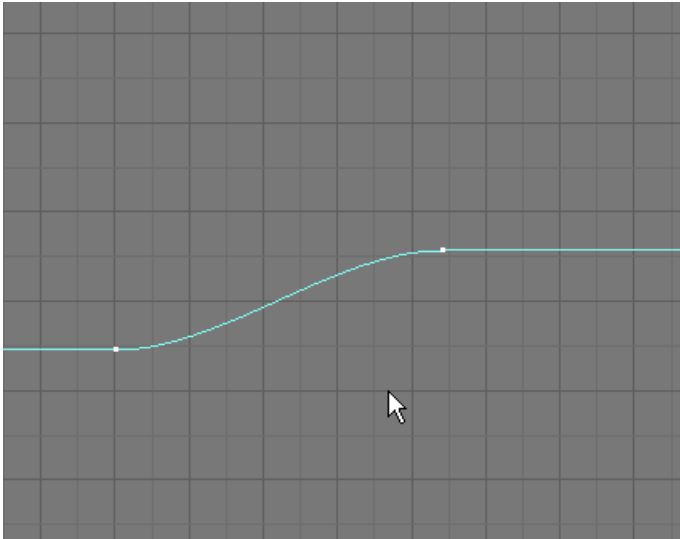

In the Curve Menu select Edit Selected.

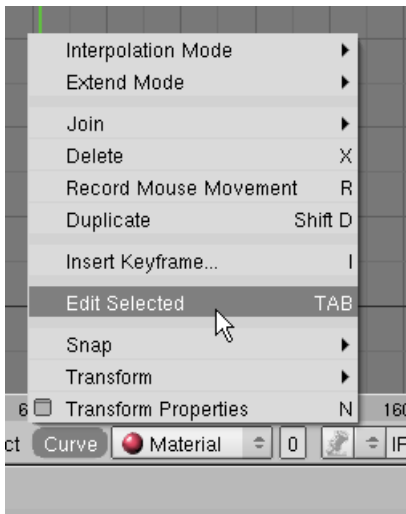

RMB select the **left control vertex**. Notice it displays a Bezier curve handle.

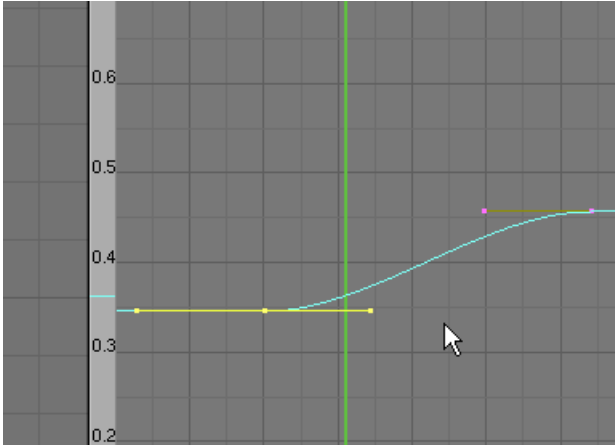

Press the NKEY (Transform Properties). In the Properties Panel set Vertex X: to 0 and Vertex Y: to 1

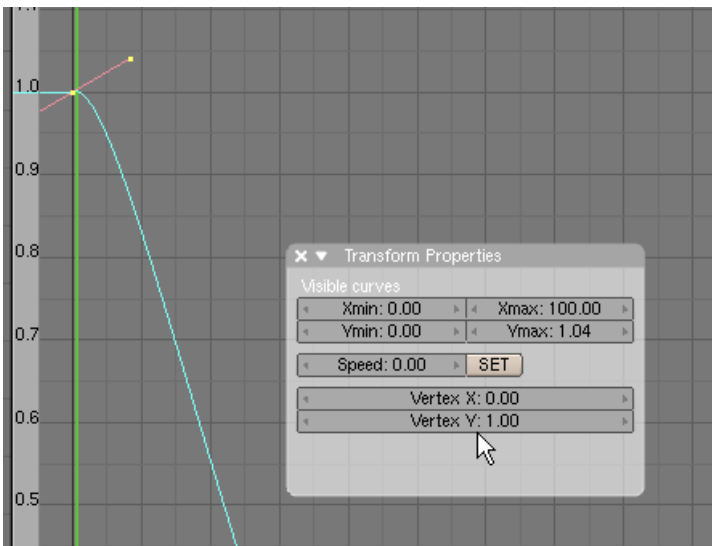

RMB select the **right control vertex**. In the Transform Properties panel set the Vertex X: to 100 and the Vertex Y: to 0

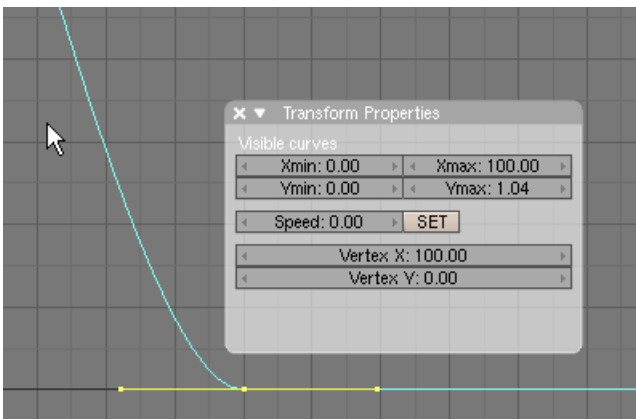

This curve represents the transparency of the color assigned to the particles. It starts at full (1) and over 100 frames lowers to none (0).

We have now animated the flame to adjust its shape a bit by adjusting the transparency.

We have a few more items to refine the candle model. Press the AKEY so nothing is selected. TAB to Object Mode. Zoom out a bit in the Side View and place your 3D cursor above the candle as shown below.

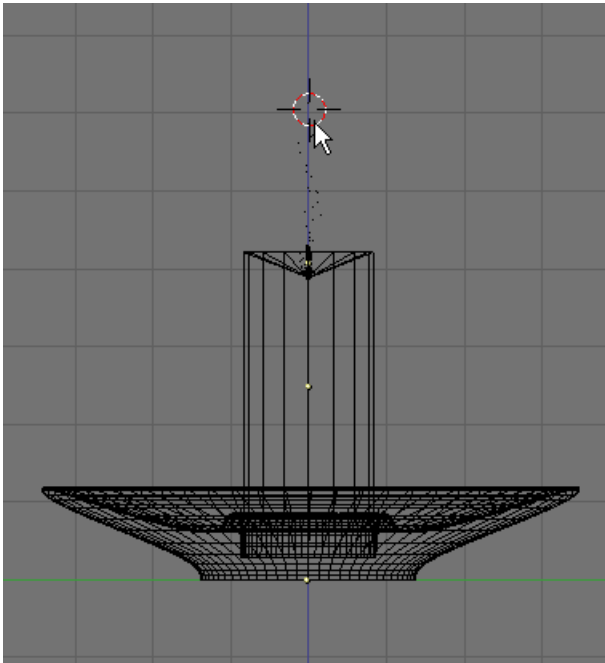

Press Space / Add / Lamp / Lamp

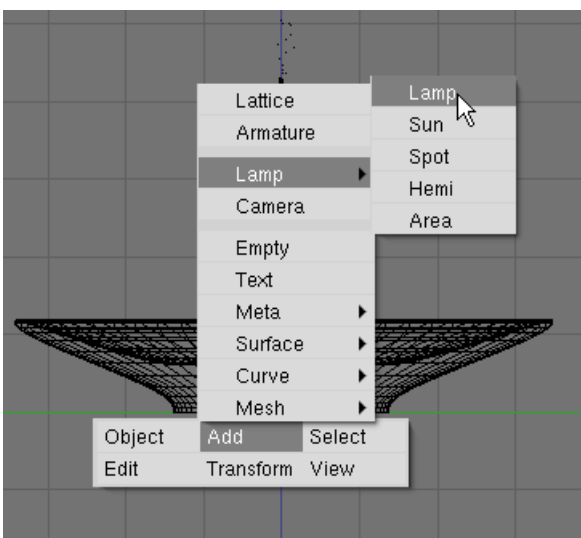

This adds a second lamp to the scene.

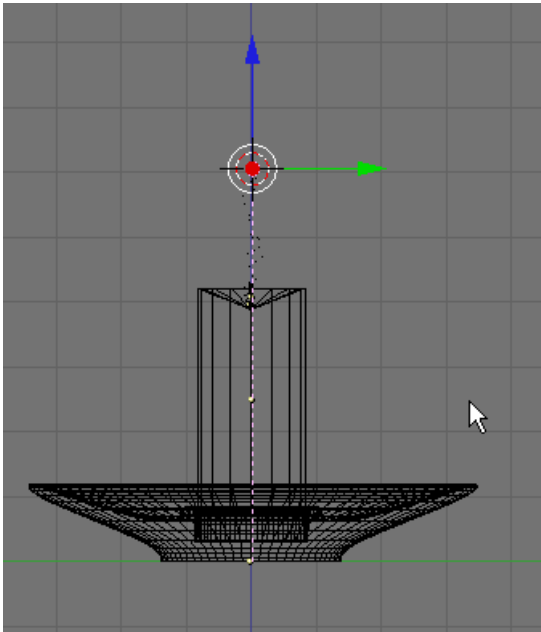

Press the AKEY to deselect the lamp. Press F5 (Shading). RMB select the new lamp. In the lamp panel, set the color sliders to Red: 1, Green: 1 and Blue: .513. Set the energy to .513

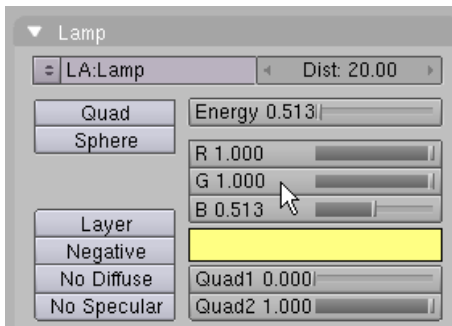

RMB select the other lamp. Reduce the energy to

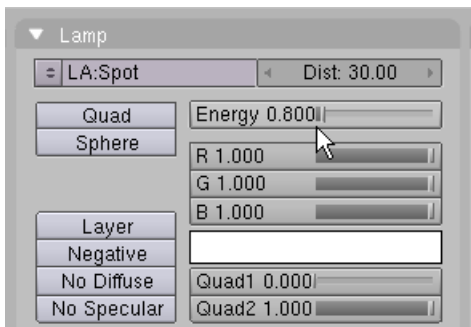

Press the World Buttons Sub Context icon.

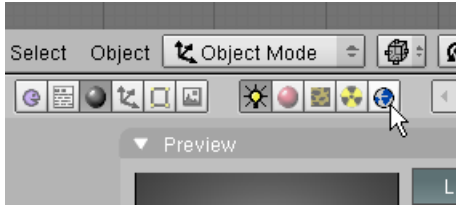

This panel controls the background. In the World Panel set all the color sliders for H, Z and Amb to 0 for a black background.

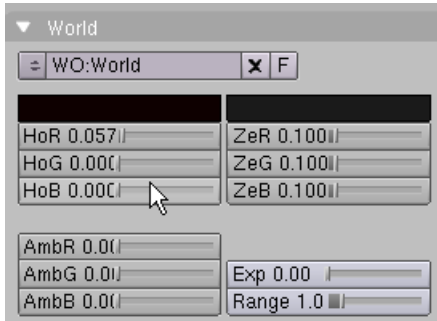

In the Amb Occ Panel press the Stars Button. Accept all of the default settings. This will add some stars to the black background.



Press F10 (Scene). In the Format Panel choose QuickTime as the file type. Since we have an animation we will create a video file.

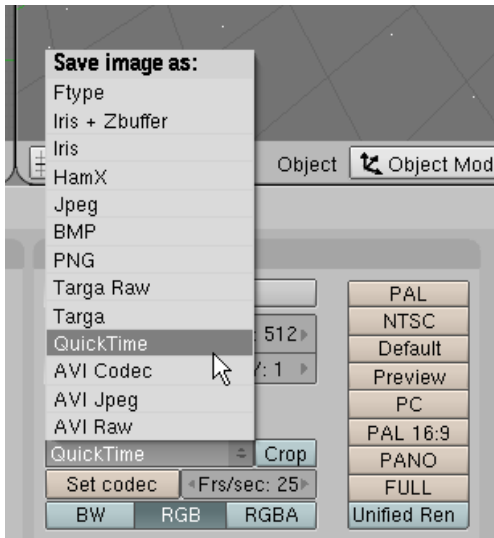

In the Animation Panel set the end frame to 100.

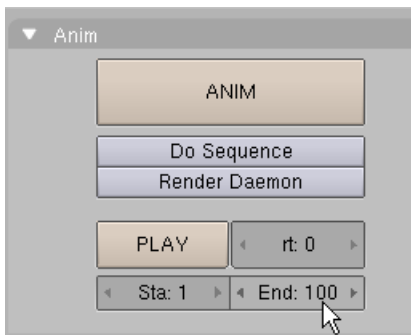

In the Output Panel click the icon on the left of the first output box.

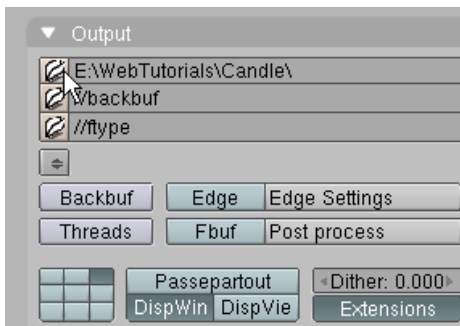

This allows you to choose where the QuickTime file will be located. Choose a directory/File and press then press the Select Output Pictures button. **NOTE: You do not name the file here – just choose the directory to save it to. (Here I have chosen C:\Temp) for the directory I want the QuickTime file to be saved)**



In the Render Panel press the Render button. This will render frame 1 to the buffer.

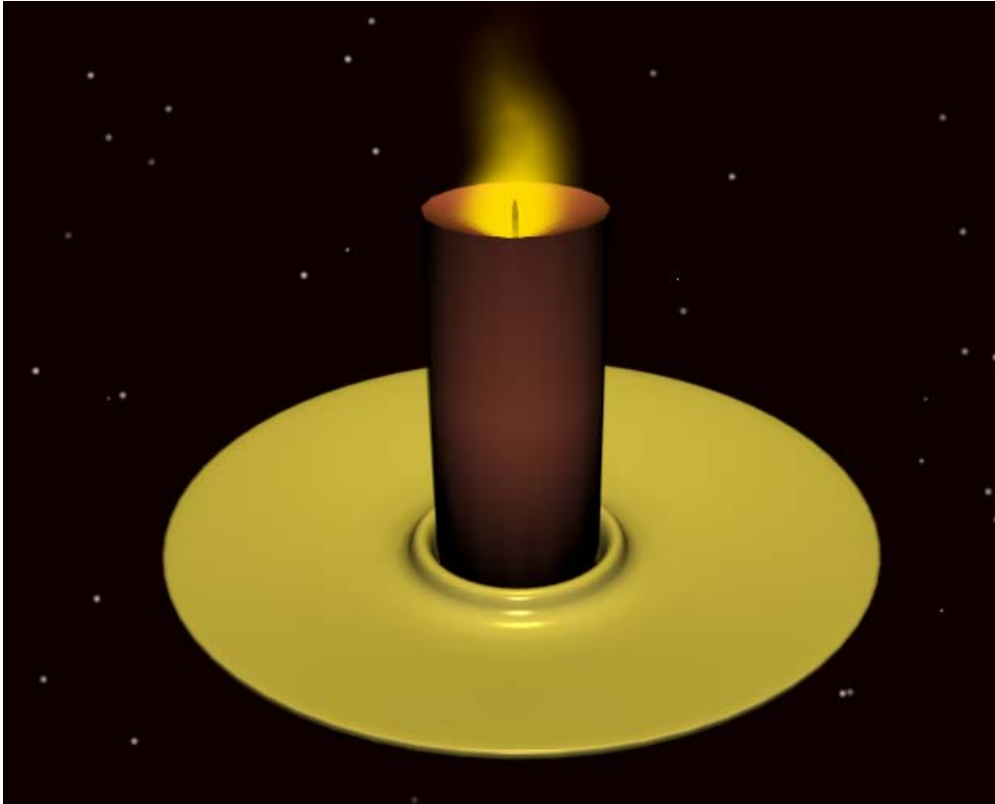

If you are happy with the rendering, press the ANIMATE button in the Animate Panel. Blender will render the 100 frames in the buffer window and create a QuickTime Video named 0001_0100.mov and place it in the output directory you have chosen.

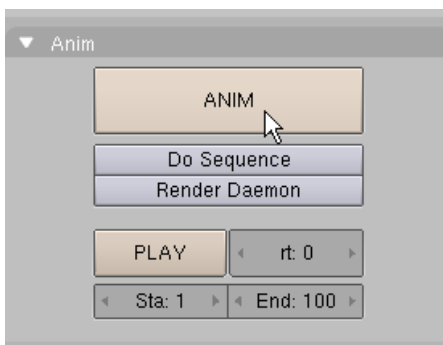

Depending on the speed of your computer and the size (and length) of the animation, this might take some time.

CandleHolder.jpg	7 KB	JPEG Image	10/14/2005 12:23 PM
0001_0100.mov	1,385 KB	QuickTime Movie	10/14/2005 8:44 PM

When finished, you can play the animation by pressing the Play button in the Animation panel or play the .mov file from the output directory through your QuickTime Player.

Save your file CTRL-W.

A completed copy of this tutorial named CandleComplete.blend is located in the Candle.zip file.